



OPTIONS

PRODUITS

LA MAISON OPTIONS

OPTIONS, CRÉATEUR DE MOMENTS INOUBLIABLES

La sortie d'un nouveau catalogue Options est en elle-même un événement... Non pas pour sa rareté, mais pour son apport en créativité pour l'aménagement et la mise en table des réceptions.

Ce catalogue est particulièrement exceptionnel au niveau de la quantité de nouveaux produits exclusifs d'art de la table mais aussi de mobilier avec des concepts totalement novateurs.

L'identité de la Maison Options est plus que jamais présente et reconnue dans les belles réceptions.

Parallèlement, nous avons la prétention de nous différencier non seulement par la profondeur et la quantité de nos gammes, mais aussi par la qualité de nos services d'accompagnement de nos clients.

Accompagnement géographique du fait de nos nombreuses implantations européennes, mais aussi accompagnement commercial dans le choix et la mise en place des réceptions.

L'ensemble de ces services sont uniques et vous assurent la sécurité, la qualité et l'originalité de l'offre.

Nos équipes sont à votre écoute.

Nous vous souhaitons une belle découverte et un bel usage de cet outil d'inspiration.

www.options.net

RSE

La Maison Options propose à ses clients un service de location s'inscrivant dans une démarche RSE. Louer pour ne pas acheter, louer pour ne pas jeter, notre métier est au cœur de cet engagement.

Depuis sa création, la Maison Options est sensible à l'application et à la défense d'une éthique tant dans le domaine commercial et des achats que dans les relations internes au sein de la société.

Les 3 piliers de la démarche RSE (économique, environnemental et sociétal) sont présents au quotidien dans les actions menées par les collaborateurs.



NOS IMPLANTATIONS

La Maison Options est présente dans 6 pays :



Retrouvez toutes nos adresses sur le site :
www.options.net

pops
location

Pop's Location vous accompagne dans l'organisation de votre événement grâce à un service de location de matériel 100% en ligne.

Commandez de la vaisselle, du mobilier ou des machines d'animation en trois clics et profitez aussi de nos offres packagées.

Pop's s'occupe de la livraison chez vous ou en point retrait ainsi que du nettoyage.

Simple et pratique !

www.pops-location.fr



COLLECTION

OPTIONS COLLECTION

Choisissez un Art de la Table unique et de grande qualité, pour des réceptions exceptionnelles.

Options Collection fait l'objet d'un catalogue spécifique.

Découvrez la totalité de l'offre sur :

www.options.net



vaisselle vintage

Vaisselle Vintage propose à la location de la vaisselle ancienne chinée, assiettes, verres, couverts et autres carafes et bougeoirs argentés, mais aussi de la déco et du mobilier.

Les produits sont chinés dans toute la France, sélectionnés avec soin et dépareillés avec charme et authenticité.

Découvrez une sélection des produits Vaisselle Vintage dans ce catalogue et l'ensemble de l'offre sur :

www.vaissellevintage.com



LA MAISON OPTIONS



La société G2V est au cœur des plus grands défilés de mode et est reconnue pour ses réalisations exceptionnelles.

G2V répond aux exigences techniques et artistiques en gardant le plus haut niveau de prestation quel que soit l'événement.

www.g2v.fr



Atawa vous accompagne dans la construction de vos événements en toute sérénité. Une offre innovante et clé en main qui regroupe tous les métiers de l'infrastructure événementielle : tente, sol, décor, mobilier, art de la table, mise en lumière, son photo vidéo, énergie et sanitaire.

Découvrez l'offre et les services sur :

www.atawa.com



Hephata valorise et finance le patrimoine !
Vous êtes propriétaire d'un monument ? Hephata Conseil vous accompagne dans son développement économique et son financement.

Vous êtes une entreprise ? Hephata Evènement donne du sens à vos événements en vous ouvrant les portes de sites historiques enchanteurs tout en vous permettant d'en soutenir la restauration.

www.hephata.fr



Options Solutions est spécialisée dans le lavage de contenants réemployables et la logistique associée pour le secteur de la restauration rapide, la restauration collective (traditionnelle et connectée), la grande distribution et l'industrie agro-alimentaire.

Son maillage territorial fort (Paris, Lyon, Aix-en-Provence, Bordeaux et Nantes) permet de réduire significativement l'empreinte écologique de la boucle du réemploi.

www.options-solutions.fr



Situation met à votre disposition des lieux inédits et d'exception pour vos tournages, shootings ou événements.

Agence événementielle, marque, société de production, photographe : notre équipe vous accompagne de A à Z pour dénicher le lieu idéal, vous apporter des services complémentaires sur mesure et rendre vos projets uniques !

Découvrez nos lieux sur : www.situation.space



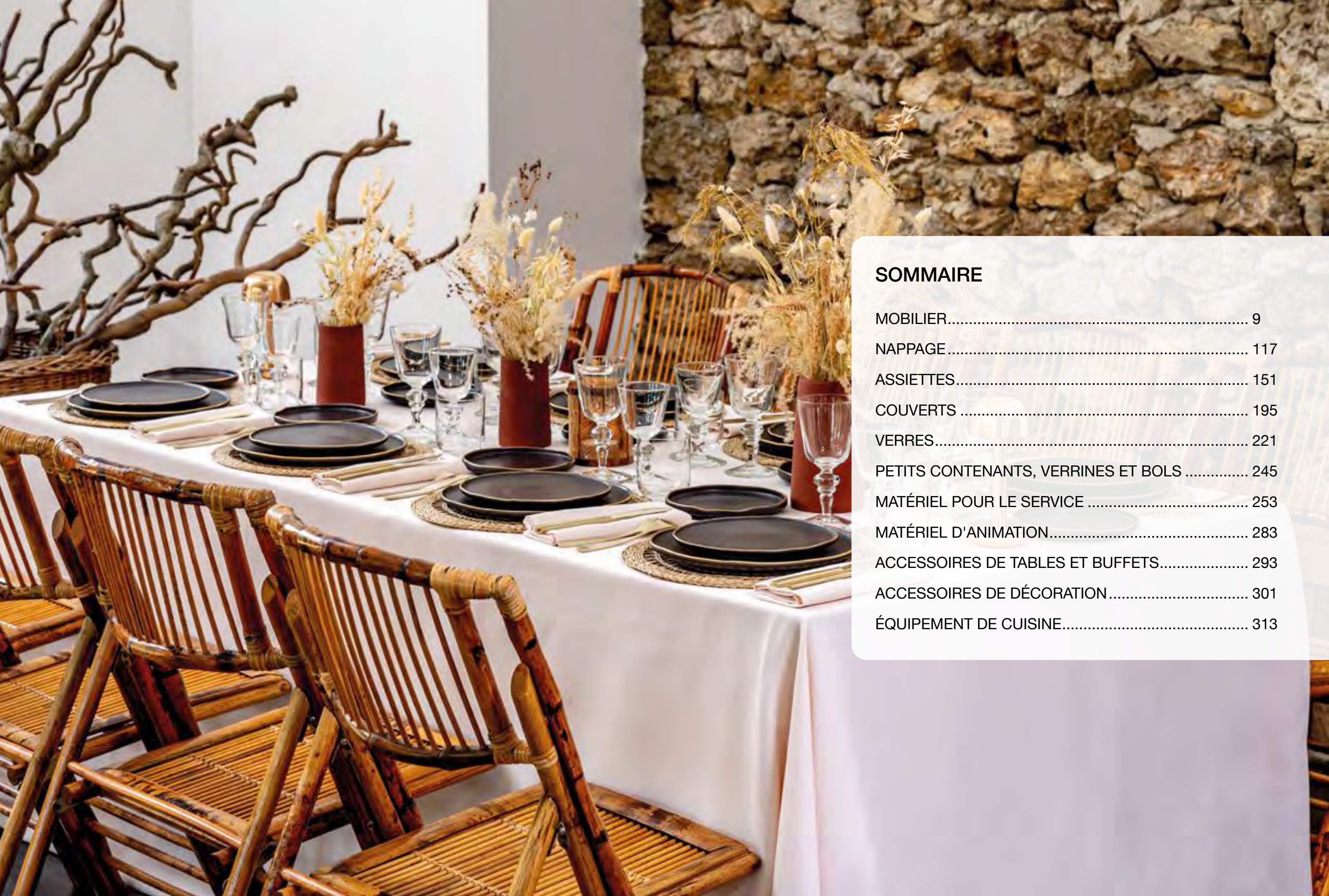

SOMMAIRE

MOBILIER.....	9
NAPPAGE.....	117
ASSIETTES.....	151
COUVERTS.....	195
VERRES.....	221
PETITS CONTENANTS, VERRINES ET BOLS.....	245
MATÉRIEL POUR LE SERVICE.....	253
MATÉRIEL D'ANIMATION.....	283
ACCESSOIRES DE TABLES ET BUFFETS.....	293
ACCESSOIRES DE DÉCORATION.....	301
ÉQUIPEMENT DE CUISINE.....	313

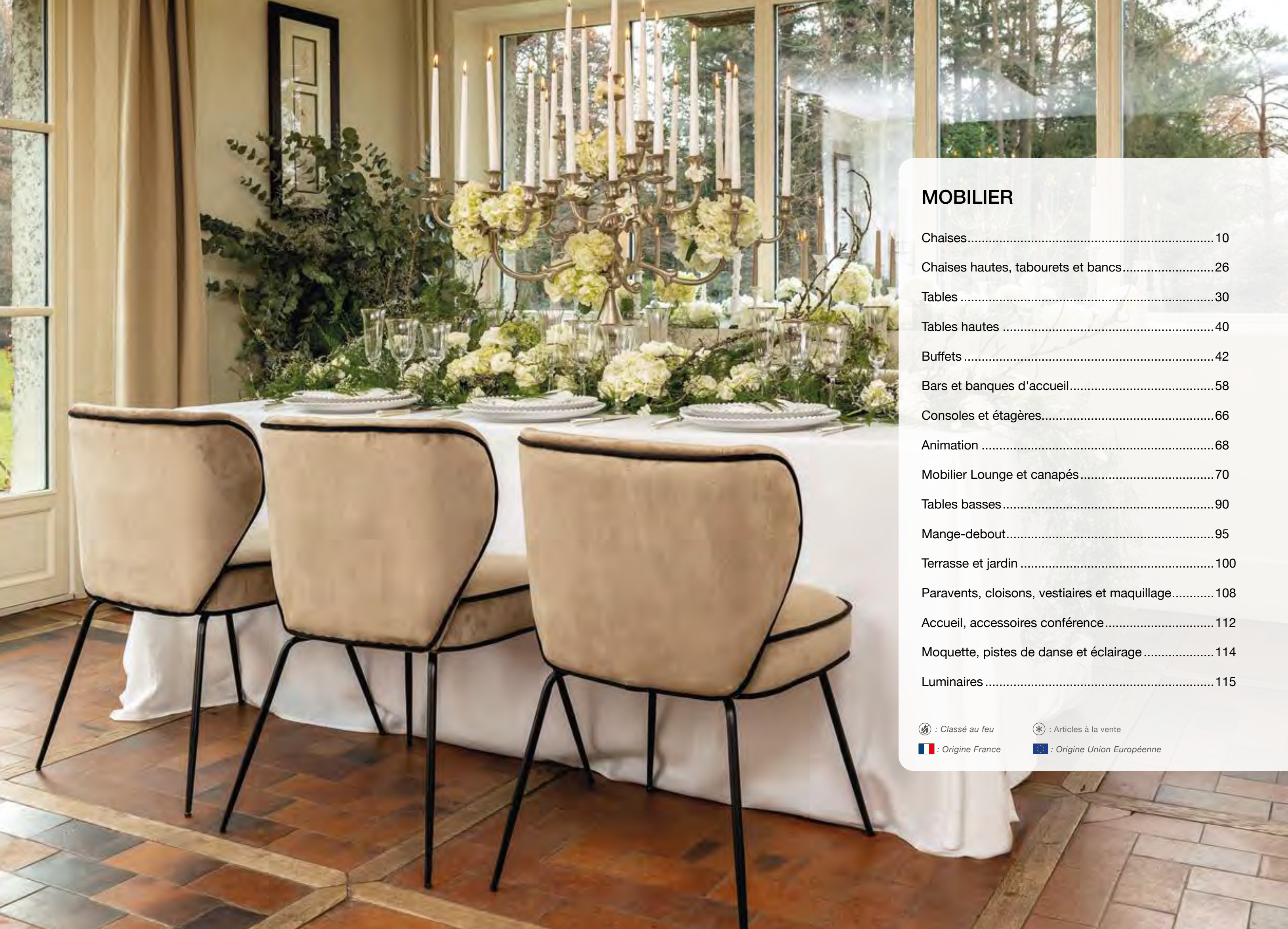

MOBILIER

Chaises.....	10
Chaises hautes, tabourets et bancs.....	26
Tables	30
Tables hautes	40
Buffets	42
Bars et banques d'accueil.....	58
Consoles et étagères.....	66
Animation	68
Mobilier Lounge et canapés.....	70
Tables basses	90
Mange-debout.....	95
Terrasse et jardin	100
Paravents, cloisons, vestiaires et maquillage.....	108
Accueil, accessoires conférence.....	112
Moquette, pistes de danse et éclairage	114
Luminaires	115

 : Classé au feu

 : Articles à la vente

 : Origine France

 : Origine Union Européenne

CHAISES

GAMME STANDARD ★☆☆☆

Festival
page 12

Deauville
page 12

Minorca
page 12

Trocadéro
page 12

Capitonée
page 12

Opale
page 13

Conférence grise
page 13

GAMME ÉLÉGANCE ★★☆☆

Bambou
page 13

Napoléon III blanche
page 14

 Autres coloris
disponibles

Napoléon III acier
page 14

 Autres coloris
disponibles

Napoléon III dorée
page 15

 Autres coloris
disponibles

Napoléon III noire
page 15

 Autres coloris
disponibles

Bellini
page 18

Napoléon III Cristal
page 18

Cristal
page 18

Sila
page 18

GAMME ÉLÉGANCE ★★☆☆

Amboise
page 18

Jack
page 18

Metteur en scène
page 18

Chantilly
page 19

Saint-Rémy
page 19

Louisiane
page 19

Pyramide
page 19

Bali
page 19

Vannerie
page 19

Bistrot
page 22

Tressée
page 22

Sphinx
page 22

GAMME EXCLUSIVE ★★★☆☆

 Autres coloris
disponibles

Dandy
page 22

Beverly
page 22

Toscane
page 22

Florence
page 22

GAMME EXCELLENCE ★★★★★

Napoléon III Chrome
page 23

Montaigne
page 23

Montaigne
page 23

Napoléon III
page 23

CHAISES

GAMME STANDARD ★☆☆☆



368
Chaise Festival
🇫🇷



0023
Chaise Deauville
🇫🇷



10064
Chaise Deauville
avec galette blanche
🇫🇷



26817
Chaise Minorca
blanche



10804
Barre de liaison pour chaise
capitonnée
🇫🇷



11261
Chaise Trocadéro
blanche
🇫🇷



11941
Chaise Trocadéro
blanche avec assise
et dossier blanc
🇫🇷



10208
Chaise Trocadéro
verte
🇫🇷



11860
Chaise Trocadéro
verte avec assise
et dossier blanc
🇫🇷



25684
Chaise Trocadéro
Wood
🇫🇷



20523
Chaise Opale



25599
Chaise capitonnée
black & black
🇫🇷



643
Chaise capitonnée bleu
trianon
🇫🇷



024
Chaise capitonnée
noire
🇫🇷



645
Chaise capitonnée
rouge
🇫🇷



18008
Chaise capitonnée
taupe
🇫🇷



17807
Chaise Bambou
assise caramel



20829
Chaise Bambou
assise écru



27071
Chaise Bambou blanche
assise blanche
🇪🇺



29508
Chaise Bambou or
assise écru



28302
Chaise Bambou or
assise velours or

GAMME STANDARD ★☆☆☆



11387
Lien de chaise
capitonnée en inox
🇫🇷

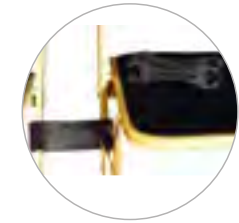

0792
Lien de chaise
capitonnée en plastique
🇫🇷



665
Chaise Conférence
grise
🇫🇷



10069
Chaise Conférence
grise avec tablette
🇫🇷

GAMME ÉLÉGANCE ★★☆☆

CHAISES

GAMME ÉLÉGANCE ☆☆☆



11787
Chaise Napoléon III
blanche enfant



457
Chaise Napoléon III
blanche fixe



290
Chaise Napoléon III
blanche pliante



4582
Chaise Napoléon III
blanche pliante cannée



055
Chaise Napoléon III
dorée fixe velours rouge



GAMME ÉLÉGANCE ☆☆☆

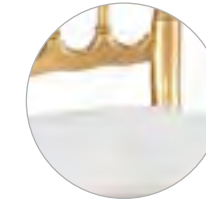

11881
Chaise Napoléon III
dorée fixe chintz blanc

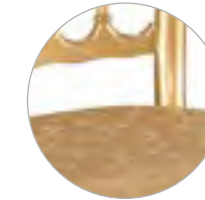

10020
Chaise Napoléon III
dorée fixe Gala or



10019
Chaise Napoléon III
dorée fixe Gala blanc

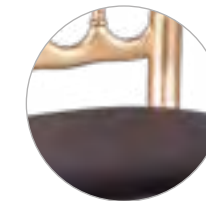

14173
Chaise Napoléon III
dorée fixe chintz noir

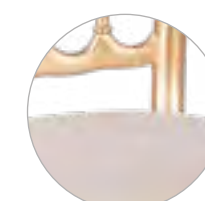

13840
Chaise Napoléon III
dorée fixe Dubaï doré

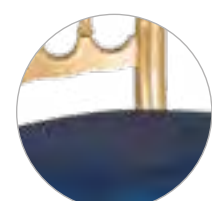

25000
Chaise Napoléon III
dorée fixe Toscane bleu nuit

(i) Autres galettes disponibles sur demande.



11606
Chaise Napoléon III acier
fixe chintz blanc



13174
Chaise Napoléon III acier
fixe chintz noir



25044
Chaise Napoléon III acier
fixe Toscane bleu nuit



11884
Chaise Napoléon III acier
fixe Toscane acier

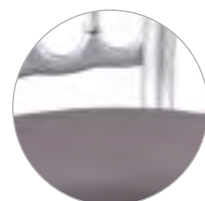

23035
Chaise Napoléon III acier
fixe Toscane bronze

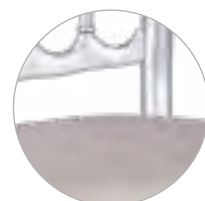

26702
Chaise Napoléon III acier
fixe Toscane taupe



14171
Chaise Napoléon III acier
fixe Delhi prune



12926
Chaise Napoléon III noire
fixe chintz noir

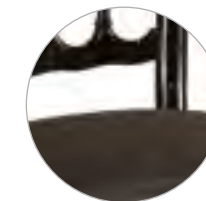

14403
Chaise Napoléon III
noire fixe Toscane acier



15592
Chaise Napoléon III
noire fixe chintz blanc



24572
Chaise Napoléon III
noire fixe Toscane bleu nuit



14915
Chaise Napoléon III
noire fixe velours rouge



28240
Chaise Napoléon III
noire fixe chintz beige



15649
Chaise Napoléon III
noire fixe Toscane rouge opéra

(i) Autres galettes disponibles sur demande.

(i) Autres galettes disponibles sur demande.



CHAISES

GAMME ÉLÉGANCE ★★☆☆



9936
Chaise Bellini



10819
Chaise Bellini
avec coussin noir



16098
Chaise Napoléon III
Cristal



16461
Chaise Napoléon III
Cristal avec assise blanche



12901
Chaise Cristal



35465
Chaise Chantilly blanche
en fer forgé



35467
Chaise Chantilly blanche
en fer forgé avec coussin



21404
Chaise Saint-Rémy



29989
Chaise Saint-Rémy
avec coussin écru

GAMME ÉLÉGANCE ★★☆☆



28409
Chaise Sila rouge



28410
Chaise Sila bleue



28411
Chaise Sila orange



28412
Chaise Sila noire



12849
Chaise Amboise



1003
Chaise Louisiane



10068
Chaise Louisiane
avec galette lin



10067
Chaise Louisiane
avec galette Caviar



16264
Chaise Pyramide
noire mat avec assise
velours noir



13919
Chaise Pyramide
noire mat



25601
Chaise séminaire Jack
noire



25680
Chaise séminaire Jack noire
avec tablette



25602
Barre de liaison chaise séminaire
Jack noire



20811
Chaise metteur en scène
noire



33987
Chaise Bali pliante
avec coussin crème



33988
Chaise Bali pliante



34175
Fauteuil Vannerie



21823
Fauteuil en rotin

(i) Marquage de couleur au dos des chaises possible. Devis sur demande.



CHAISES

GAMME ÉLÉGANCE ★★☆☆



30823
Chaise Bistrot



34066
Chaise Bistrot
avec galette lin ficelle



35679
Chaise Bistrot noire



29997
Chaise tressée
noire et blanche



36107
Chaise Sphinx
avec coussin crème

GAMME EXCELLENCE ★★★★



17650
Chaise Napoléon III Chrome



18627
Chaise Montaigne black
and black •



16289
Chaise Montaigne black
and white •



18007
Chaise Montaigne
blanche •

GAMME EXCLUSIVE ★★★★☆



35715
Chaise Dandy
velours bleu



35717
Chaise Dandy
velours taupe



35718
Chaise Dandy
velours vert



35716
Chaise Dandy
velours noir



34414
Chaise Montaigne cannée



19428
Chaise Montaigne grey stone •



27073
Chaise Montaigne nature



28542
Chaise Montaigne or •



28335
Chaise Beverly
assise crème •



28337
Chaise Beverly
assise noire •



27074
Chaise Toscane
avec coussin crème
35987
Chaise Toscane
avec coussin blanc



35814
Chaise Florence
en fer forgé



35816
Chaise Florence
en fer forgé
avec coussin crème



14453
Chaise Montaigne perle •



20178
Fauteuil Montaigne blanc •



30831
Fauteuil Montaigne nature



323
Fauteuil Napoléon III rouge



CHAISES HAUTES, TABOURETS ET BANCS



19581
Tabouret bois
Ø 27 cm H 72 cm



297
Tabouret Z
H 80/81 cm noir



24630
Tabouret Z
H 80/81 cm blanc



21373
Chaise haute noire
H 111 cm



25687
Tabouret réglable noir
Thin H 54 à 79 cm



13096
Tabouret Cristal
H 75 cm



13925
Tabouret Cristal noir
H 75 cm



32839
Tabouret Juliette
H 75 cm



28405
Chaise haute Sila rouge
H 100 cm



28406
Chaise haute Sila bleue
H 100 cm



28407
Chaise haute Sila orange
H 100 cm



28408
Chaise haute Sila noire
H 100 cm



25686
Chaise haute Sila blanche
H 100 cm



32806
Tabouret Saint Rémy
H 72 cm Ø 27 cm



20813
Chaise haute bébé
H 90 cm L 58 P 62 cm



3650
Banc en bois naturel 25 x 220 cm H 47 cm



28424
Banc Kermesse noir 25 x 220 cm H 47 cm



29721
Tabouret industriel blanc
H 76 cm



29988
Tabouret industriel blanc
assise bois H 78 cm



28594
Tabouret industriel
H 76 cm



30061
Tabouret industriel
assise bois H 78 cm



25688
Banc Icône blanc
40 x 160 cm H 47 cm

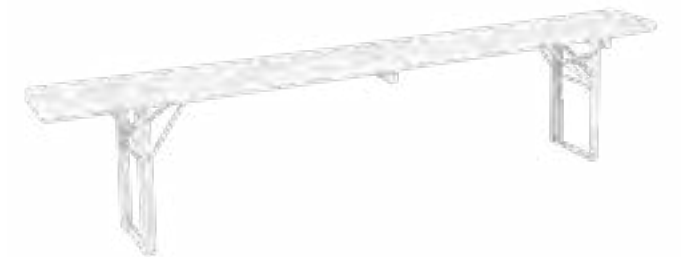

20557
Banc Kermesse blanc 25 x 220 cm H 47 cm



28322
Banc nature en chêne 30 x 240 cm H 47 cm



16382
Housse de banc blanche 25 x 220 cm H 50 cm
avec assise mousse



TABLES



054
Guéridon Ø 70 cm
350
Guéridon Ø 70 cm •

25254
Guéridon Ø 70 cm pieds ciseaux
025
Table ronde Ø 100 cm
026
Table ronde Ø 120 cm
3026
Table ronde Ø 135 cm



027
Table ronde Ø 150 cm
390
Table ronde Ø 150 cm •

275
Table ronde Ø 170 cm
10017
Table ronde Ø 185 cm
047
Table ronde Ø 200 cm
357
Table ronde Ø 200 cm •



412
Table desserte 60 x 60 cm
36057
Table desserte 70 x 90 cm pieds ciseaux
363
Table desserte 70 x 90 cm •

747
Table rectangulaire 50 x 200 cm
438
Table rectangulaire 80 x 150 cm
439
Table rectangulaire 80 x 200 cm
319
Table rectangulaire 80 x 220 cm
029
Table rectangulaire 100 x 150 cm
030
Table rectangulaire 100 x 200 cm



29201
Table rectangulaire 100 x 230 cm
24167
Table rectangulaire 130 x 200 cm



355
Table ovale 100 x 200 cm
046
Table ovale 100 x 250 cm
9704
Table ovale 100 x 300 cm

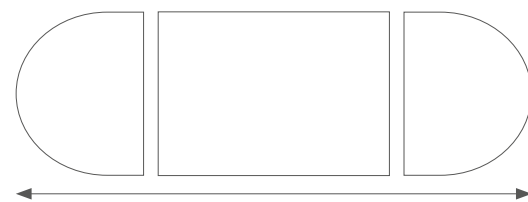

24169
Table ovale 130 x 300 cm
24170
Table ovale 130 x 500 cm
28248
Table ovale 130 x 700 cm
9723
Table ovale 150 x 300 cm
9727
Table ovale 150 x 500 cm
9731
Table ovale 150 x 700 cm

Autres dimensions disponibles sur demande.



12876
Table ovale enfants
100 x 200 cm H 52 cm



18208
Table ronde de jardin
Ø 98 cm H 72 cm (PVC blanc)



25685
Table Trocadéro ronde noire
Ø 77 cm H 74 cm •



29998
Table bistrot
Ø 70 cm H 72 cm



20654
Table Trocadéro ronde blanche
Ø 77 cm H 74 cm •



28416
Table Trocadéro carrée noire
70 x 70 cm H 74 cm •



20653
Table Trocadéro ronde verte
Ø 77 cm H 74 cm •



11441
Table carrée Louisiane
70 x 70 cm H 73 cm



14023
Table carrée noire
70 x 70 cm H 73 cm



25887
Table Icône carrée blanche
69 x 69 cm H 72 cm



744
Table de bridge
78 x 78 cm H 70 cm

TABLES



25972
Table Kermesse
80 x 220 cm H 78 cm



29986
Table Wood rectangulaire
90 x 220 cm H 77 cm



31035
Table Nature ronde
pieds métal Ø 170 cm



32852
Table Nature ronde
pieds noirs Ø 170 cm



28426
Table Kermesse noire
70 x 220 cm H 78 cm

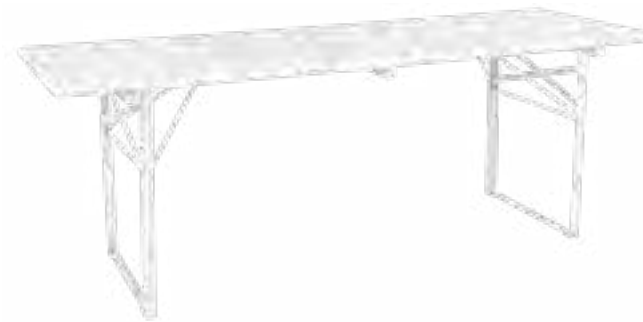

28425
Table Kermesse blanche
70 x 220 cm H 78 cm



31034
Table Nature rectangulaire en chêne
pieds noirs 100 x 240 cm H 73 cm



34442
Arche pour table Nature
Comprend les 2 supports de table,
la guirlande guinguette 5 m,
un câble rallonge de 2 m



21659
Table Nature rectangulaire en chêne
100 x 240 cm H 73 cm



13256
Ensemble table de ferme
Table : 90 x 200 cm H 72 cm
Banc : 30 x 200 cm H 44 cm



24150
Table séminaire
80 x 160 cm H 74 cm



30200
Table Filor
Ø 160 cm H 73 cm



25702
Table Icône ronde Ø 160 cm H 72 cm
25886
Table Icône ronde Ø 130 cm H 72 cm



27111
Table Wood ronde
Ø 135 cm H 75,5 cm



1004
Table Louisiane ronde
Ø 130 cm H 76 cm



21418
Table Cône noir plateau noir
140 x 140 cm H 75 cm



21433
Table Cône blanc plateau blanc
140 x 140 cm H 75 cm

TABLES



35700
Table Newave 120 x 240 cm H 74 cm



TABLES



35703
Table Marly 90 x 200 cm H 72 cm



A long wooden table with black metal legs, set with plates, glasses, and silverware.

TABLES HAUTES



28558
Table haute blanche plateau nature
80 x 230 cm H 110 cm



34445
Table haute noire plateau nature
80 x 230 cm H 110 cm



33116
Table haute Nature pieds croisés blancs
100 x 240 cm H 110 cm



33115
Table haute Nature pieds croisés noirs
100 x 240 cm H 110 cm



34471
Table haute noire plateau noir
80 x 230 cm H 110 cm



34472
Table haute noire plateau blanc
80 x 230 cm H 110 cm



29994
Table haute filaire
80 x 180 cm H 108 cm



34470
Table haute blanche plateau noir
80 x 230 cm H 110 cm

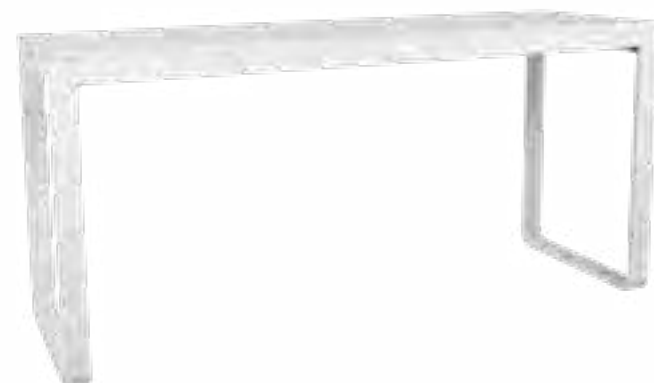

30697
Table haute blanche plateau blanc
80 x 230 cm H 110 cm



21437
Table haute Cône blanc plateau blanc
140 x 140 cm H 112 cm



21422
Table haute Cône noir plateau noir
140 x 140 cm H 112 cm

BUFFETS



001
Buffet 80 x 150 cm
002
Buffet 80 x 200 cm
500
Buffet 100 x 150 cm
501
Buffet 100 x 200 cm

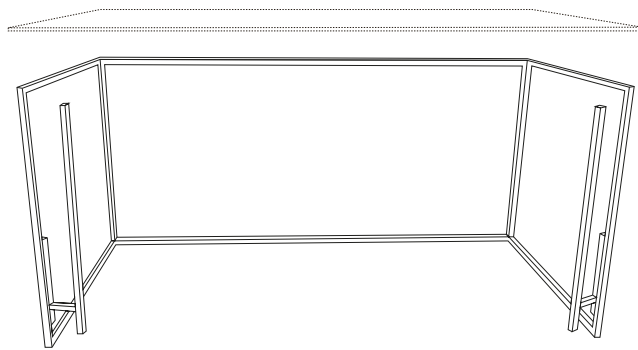

24232
Buffet pliant à napper 100 x 200 cm H 91 cm
avec kit pinces

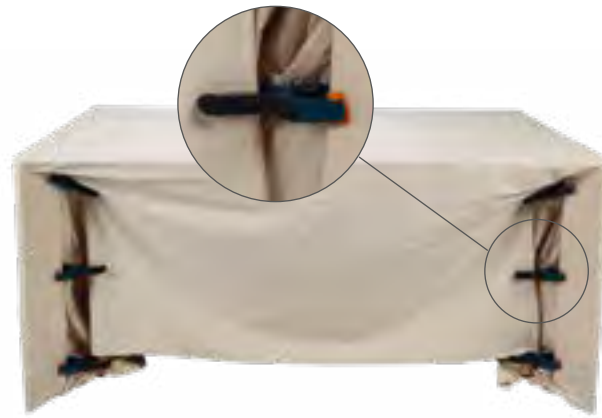

Possibilité d'utiliser tous nos coloris de nappage

i Prévoir une nappe longueur 500 cm minimum.



21023
Buffet cube lycra blanc
sur roulettes
69 x 86 cm cm H 106 cm



21022
Buffet cube lycra noir
sur roulettes
69 x 86 cm cm H 106 cm



29999
Desserte pliante
housée blanche
70 x 90 cm H 72 cm



30158
Desserte pliante
housée noire
70 x 90 cm H 72 cm



30912
Buffet Cube housé noir 3 faces
100 x 100 cm H 109 cm
30910
Buffet Cube housé noir 4 faces
100 x 100 cm H 109 cm



30913
Buffet Cube housé blanc 3 faces
100 x 100 cm H 109 cm
30911
Buffet Cube housé blanc 4 faces
100 x 100 cm H 109 cm



20418
Buffet pliant housé blanc "3 faces" 100 x 200 cm H 91 cm
20430
Buffet pliant housé blanc "3 faces" 100 x 200 cm H 91 cm
sur roulettes
20726
Buffet pliant housé blanc "3 faces" 80 x 200 cm H 91 cm
20727
Buffet pliant housé blanc "3 faces" 80 x 200 cm H 91 cm
sur roulettes

20420
Buffet pliant housé blanc "4 faces" 100 x 200 cm H 91 cm
20432
Buffet pliant housé blanc "4 faces" 100 x 200 cm H 91 cm
sur roulettes
20872
Buffet pliant housé blanc "4 faces" 80 x 200 cm H 91 cm
20874
Buffet pliant housé blanc "4 faces" 80 x 200 cm H 91 cm
sur roulettes



i Le buffet "3 faces" est idéal si vous souhaitez un espace de rangement.
Pour une disposition en îlot, choisissez le buffet "4 faces".

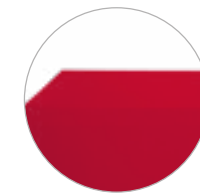

24344
Buffet pliant housé rouge "3 faces"
100 x 200 cm

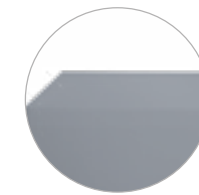

24345
Buffet pliant housé gris "3 faces"
100 x 200 cm

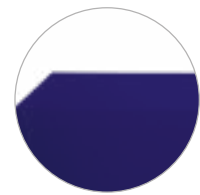

24342
Buffet pliant housé bleu "3 faces"
100 x 200 cm



11030
Buffet 1/2 rond Ø 350 cm creux
Habillage intérieur et extérieur coton gratté



11032
Buffet rond Ø 350 cm creux
Habillage intérieur et extérieur coton gratté

Nuancier des coloris
disponibles page 47

Nuancier des coloris
disponibles page 47

BUFFETS

VOTRE buffet pliant, le **SUR-MESURE** à l'infini !

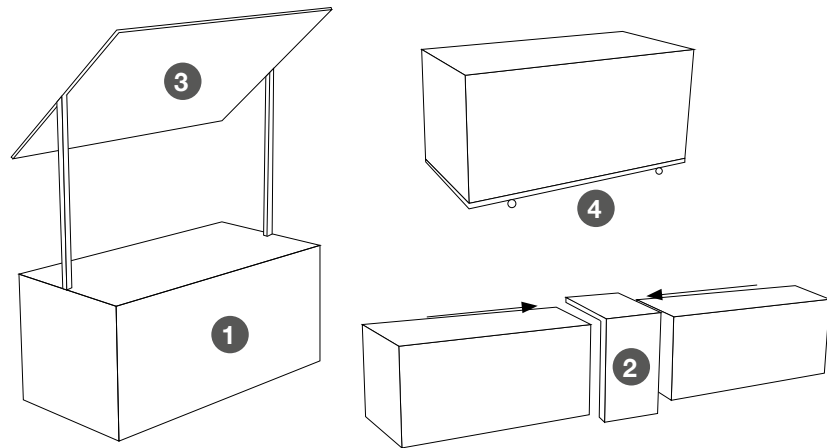

1 Buffet 2 Raccord 3 Toit 4 Socle à roulettes

1 Choisissez l'habillage de votre buffet dans la couleur et la matière de votre choix.

15124 Buffet pliant 100 x 200 cm en lackfolie
16377 Buffet pliant 100 x 200 cm en coton gratté

Nuancier des coloris disponibles page 46

2 Ajoutez un raccord. Il fait la liaison entre 2 buffets et vous permet de mettre en avant vos produits.



19079 Raccord pour buffet pliant en lackfolie 108 x 80 cm H 105 cm sans éclairage
19363 Raccord pour buffet pliant en coton gratté 108 x 80 cm H 105 cm sans éclairage

Nuancier des coloris disponibles page 46

3 Ajoutez un socle à roulettes et rendez vos buffets mobiles.

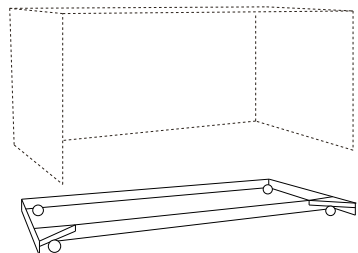

20723 Socle à roulettes pour buffet pliant 80 x 200 cm
20428 Socle à roulettes pour buffet pliant 100 x 200 cm

4 Ajoutez un toit à votre buffet.



19090 Toit tôle pour buffet pliant 140 x 206 cm H 127 cm

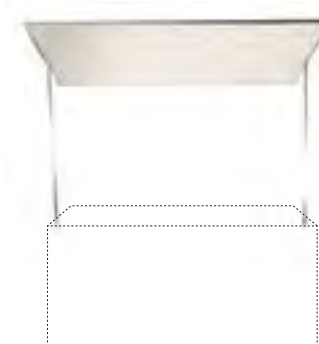

19583 Toit miroir pour buffet pliant 140 x 206 cm H 127 cm



ARCHES pour buffet

Découvrez nos arches pour buffets, elles sublimeront vos mets et vos présentations. Nos arches s'adaptent sur tous les buffets Options.

Arches composées

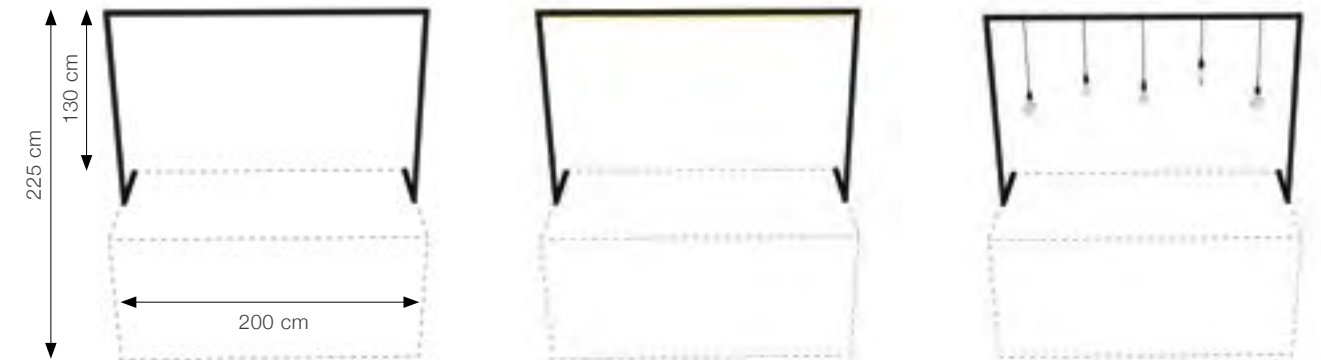

34731 Arche nue pour buffet pliant

34733 Arche Led pour buffet pliant

34734 Arche ampoules rétro pour buffet pliant

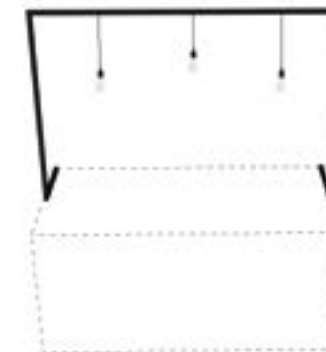

34736 Arche sans abat-jour pour buffet pliant à personnaliser



34744 Arche abat-jour Indus pour buffet pliant

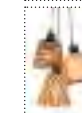

34745 Arche abat-jour Rotin pour buffet pliant

Accessoires pour arches



34732 Tablette pour arche

i 3 positions possibles pour la tablette : hauteur 15, 25 ou 35 cm



34737 Grille de suspension pour arche

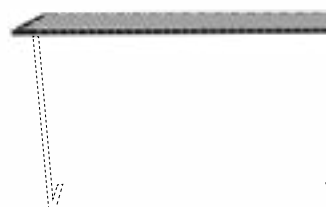

34738 Toiture bâche pour arche



34739 Toiture de marché pour arche L 205 H 244 cm

BUFFETS

CHINTZ



LACKFOLIE •



COTON GRATTÉ





BUFFETS

 TOUS NOS BUFFETS SONT FABRIQUÉS EN FRANCE



27066
Buffet Cigare Club beige
100 x 200 cm H 92 cm



36045
Buffet Cigare Club noir
100 x 200 cm H 90 cm



36046
Buffet Beauvallon
100 x 200 cm H 90 cm



25801
Buffet pliant Deck
100 x 200 cm H 92 cm

*Découvrez également le bar assorti page 58,
le bar buffet page 60 et l'étagère page 67.*



36023
Bar Cigare Club Beige
55 x 150 cm H 115 cm

*Découvrez également le bar assorti page 58,
le bar buffet page 60 et l'étagère page 67.*



36021
Bar Cigare Club Noir
55 x 150 cm H 115 cm

*Découvrez également le bar assorti page 58,
le bar buffet page 61 et l'étagère page 67.*



36022
Bar Beauvallon
55 x 150 cm H 115 cm

*Découvrez également le bar assorti page 58,
le bar buffet page 61 et le mange-debout page 98.*



31016
Bar Deck
55 x 150 cm H 115 cm



36113
Bar buffet Cigare Club beige
100 x 200 cm H 110 cm



36119
Bar buffet Cigare Club noir
100 x 200 cm H 110 cm



36111
Bar buffet Beauvallon
100 x 200 cm H 110 cm



36121
Bar buffet Deck
100 x 200 cm H 110 cm



36114
Etagère Cigare Club beige
40 x 80 cm H 120 cm



36116
Etagère Cigare Club noir
40 x 80 cm H 120 cm



36108
Etagère Beauvallon
40 x 80 cm H 120 cm



31028
Mange-debout Deck
60 x 60 cm H 115 cm

BUFFETS

 TOUS NOS BUFFETS SONT FABRIQUÉS EN FRANCE



31020
Buffet Cap Ferret
100 x 200 cm H 90 cm

*Découvrez également le bar assorti page 58 et le
mange-debout page 98.*



31015
Bar Cap Ferret
55 x 150 cm H 115 cm



31027
Mange-debout Cap Ferret
60 x 60 cm H 115 cm



31024
Buffet Mandarin
100 x 200 cm H 90 cm

*Découvrez également le bar assorti page 58 et le
mange-debout page 98.*



31017
Bar Mandarin
55 x 150 cm H 115 cm



31029
Mange-debout Mandarin
60 x 60 cm H 115 cm



36048
Buffet Treillage
100 x 200 cm H 90 cm

*Découvrez également le bar assorti
page 58.*



36024
Bar Treillage
55 x 150 cm H 115 cm



25798
Buffet pliant Sakiro noir
100 x 228 cm H 91 cm avec joues



26460
Buffet pliant Sakiro blanc
100 x 228 cm H 91 cm avec joues



25791
Buffet pliant Gatsby
100 x 200 cm H 92 cm *



16219
Buffet pliant minéral 100 x 200 cm H 92 cm *



30167
Buffet pliant Palissade Pacific
100 x 200 cm H 92 cm

*Découvrez également le bar assorti page 58 et le
mange-debout page 98.*



31018
Bar Palissade Pacific pliant
55 x 150 cm H 120 cm



31033
Mange-debout Palissade Pacific
60 x 60 cm H 115 cm



19182
Buffet pliant miroir 100 x 200 cm H 92 cm
(façades et plateau miroir)

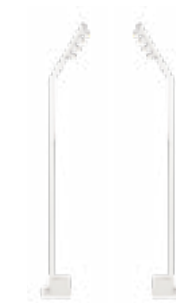

28438
Lot de 2 lampadaires
multidirectionnels blancs H 230 cm
Alimentation autonome

 * Décor de façade : bâche imprimée

BUFFETS

 TOUS NOS BUFFETS SONT FABRIQUÉS EN FRANCE



25789
Buffet pliant piano de cuisine 100 x 200 cm*



26211
Buffet pliant animation Piano de cuisine 100 x 200 cm*
Dessus inox, chafing dish et plaque vitro de maintien en température (2 chafing dish électriques et une plaque vitro de maintien en température)**



16085
Buffet pliant en lackfolie
banc à huîtres 100 x 200 cm H 92 cm

 Nuancier des coloris disponibles page 46



16379
Buffet pliant en lackfolie
salades bar 100 x 200 cm H 92 cm

 Nuancier des coloris disponibles page 46



26210
Buffet pliant animation Piano de cuisine 100 x 200 cm*
Dessus inox, chafing dish et plancha 100 x 200 cm (2 chafing dish et une plancha)**



26209
Buffet pliant animation Piano de cuisine 100 x 200 cm*
Dessus inox, chafing dish 100 x 200 cm (3 chafing dish électriques)**

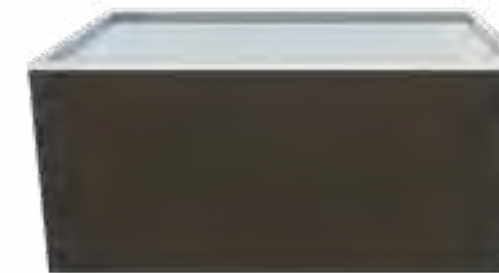

34758
Buffet pliant en lackfolie avec plateau
banc à huîtres inox 100 x 200 cm H 92 cm

 Nuancier des coloris disponibles page 46



34762
Buffet pliant Ardoise avec plateau
banc à huîtres inox 100 x 200 cm H 92 cm



19070
Buffet pliant tôle 100 x 200 cm H 92 cm
19066
Buffet pliant tôle 100 x 200 cm avec toit tôle



19097
Buffet pliant barbecue
100 x 200 cm
avec toit tôle



34759
Buffet pliant Cap Ferret avec plateau
banc à huîtres inox 100 x 200 cm H 92 cm



34760
Buffet pliant Palissade Pacific avec plateau
banc à huîtres inox 100 x 200 cm H 92 cm



19178
Buffet pliant plancha
100 x 200 cm
avec toit tôle
19064
Buffet pliant plancha
100 x 200 cm

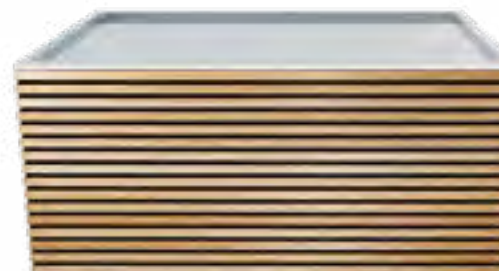

34761
Buffet pliant Deck avec plateau
banc à huîtres inox 100 x 200 cm H 92 cm

 * Décor de façade : bâche imprimée

** Les plateaux animation ci-dessus s'adaptent à tous les buffets pliants sur demande.



BARS ET BANQUES D'ACCUEIL

 TOUS NOS BARS SONT FABRIQUÉS EN FRANCE



31018
Bar Palissade Pacific pliant
55 x 150 cm H 120 cm
Découvrez également le buffet assorti page 52 et le mange-debout page 98.



31015
Bar Cap Ferret
55 x 150 cm H 115 cm
Découvrez également le buffet assorti page 52 et le mange-debout page 98.



31017
Bar Mandarin
55 x 150 cm H 115 cm
Découvrez également le buffet assorti page 53 et le mange-debout page 98.



31016
Bar Deck
55 x 150 cm H 115 cm
Découvrez également le buffet assorti page 51 et le mange-debout page 98.



36023
Bar Cigare Club Beige
55 x 150 cm H 115 cm
Découvrez également le buffet assorti page 50.



36021
Bar Cigare Club Noir
55 x 150 cm H 115 cm
Découvrez également le buffet assorti page 50.



36022
Bar Beauvallon
55 x 150 cm H 115 cm
Découvrez également le buffet assorti page 51.



36024
Bar Treillage
55 x 150 cm H 115 cm
Découvrez également le buffet assorti page 52.



BARS ET BANQUES D'ACCUEIL

 TOUS NOS BARS SONT FABRIQUÉS EN FRANCE



36113
Bar buffet Cigare Club beige
100 x 200 cm H 110 cm



36119
Bar buffet Cigare Club noir
100 x 200 cm H 110 cm



36111
Bar buffet Beauvallon
100 x 200 cm H 110 cm



36121
Bar buffet Deck
100 x 200 cm H 110 cm



BARS ET BANQUES D'ACCUEIL



21515
Module droit Bar light
55 x 200 cm H 115 cm
Alimentation autonome

 Couleurs programmables
avec une télécommande



21514
Module d'angle Bar light
55 x 100 cm H 115 cm
Alimentation autonome

 Couleurs programmables
avec une télécommande



27057
Banque d'accueil pliante Bergen
35 x 120 cm H 110 cm



27056
Banque d'accueil pliante blanche
35 x 120 cm H 110 cm



27059
Bar Igloo lumineux module droit équipé
75 x 140 cm H 108 cm

27058
Bar Igloo lumineux module d'angle
90 x 89,5 cm H 108 cm
Alimentation autonome

 Couleurs programmables
avec une télécommande



i Ce bar est composé d'un évier, de petits bacs GN, d'une planche à découper, d'emplacements pour bouteilles et d'un plan de travail



13324
Banque d'accueil lackfolie
40 x 200 cm H 110 cm

13338
Banque d'accueil lackfolie
40 x 150 cm H 110 cm



13323
Banque d'accueil coton gratté
40 x 200 cm H 110 cm

13337
Banque d'accueil coton gratté
40 x 150 cm H 110 cm

 Nuancier des coloris disponibles page 46



24922
Comptoir lumineux autonome
50 x 150 cm H 110 cm



14093
Buffet Vision
100 x 200 cm H 110 cm



19185
Banque d'accueil Vision
40 x 200 cm H 110 cm

i Façade ouverture "fenêtre", miroir au fond et sur les côtés, éclairage par spots basse tension.
Dimensions de l'ouverture : L 164 cm P 30 cm H 64 cm



13249
Bar tonneau
L 200 cm H 100 cm



1127
Bar bistrot
50 x 125 cm H 110 cm



CONSOLES ET ÉTAGÈRES



35926
Console Filor cuivrée
32 x 110 cm H 78 cm



36130
Etagère dorée et blanche
40 x 80 cm H 180 cm



36129
Etagère dorée et noire
40 x 80 cm H 180 cm



36128
Etagère dorée et bois
40 x 80 cm H 180 cm



36132
Etagère noire
40 x 80 cm H 180 cm



36131
Etagère noire et blanche
40 x 80 cm H 180 cm



36133
Etagère noire et bois
40 x 80 cm H 180 cm



36114
Etagère Cigare Club beige
40 x 80 cm H 120 cm
Découvrez également le buffet assorti page 50.



36108
Etagère Beauvallon
40 x 80 cm H 120 cm
Découvrez également le buffet assorti page 51.



36116
Etagère Cigare Club noir
40 x 80 cm H 120 cm
Découvrez également le buffet assorti page 50.



i Les étagères complètent l'aménagement des arrières de bars et de buffets. Vous pouvez les superposer ou les placer l'une à côté de l'autre.

ANIMATION



23123
Desserte noire plateau bois
48 x 71 cm H 70 cm



18076
Table roulante cocktail noire
60 x 90 cm H 95 cm



26205
Table roulante cocktail blanche
60 x 90 cm H 95 cm



27117
Présentoir café
45 x 65 cm H 112 cm



126
Voiture à glace décorative
75 x 128 cm H 213 cm



220
Cuillère à glace
automatique



29041
Voiture à glace réfrigérée
Bloc de réfrigération de 296 L
Alimentation électrique 220 V
105 x 135 cm H 207 cm



20460
Triporteur animation



20806
Pack animation glace pour triporteur
Contient un bac
de 20 Kg de glace paillette
et un bac à glace de 60 L.
Triporteur non inclus dans le pack.

20807
Parasol pour triporteur
Contient un support
de parasol et son parasol.
Triporteur non inclus dans le pack.

ⓘ Avec son coffre permettant de stocker matériel et batterie pour une machine à café par exemple, le triporteur s'adapte à toutes les utilisations, en intérieur comme en extérieur. Commandez votre triporteur puis ajoutez un des packs ci-dessous.

ⓘ Emplacements pour bacs à l'arrière, passe-câble, idéal pour poste pause café.

ⓘ Suggestion de présentation, photo non contractuelle



127
Voiture 4 saisons
78 x 182 cm H 198 cm



30926
Etal de marché
104 x 175 cm H 205 cm



29432
Décor food truck
L 430 cm H 220 cm P 150 cm

ⓘ Ce décor est une réplique en trompe l'œil d'une façade de food truck. Derrière ce décor se trouvent une tablette, une étagère, un espace de stockage et un rideau noir.

MOBILIER LOUNGE ET CANAPÉS



18890
Chauffeuse Dance Floor
50 x 70 cm •



12783
Pouf rond vinyle blanc
Ø 50 cm H 45 cm •



11608
Banquette vinyle blanc
50 x 150 cm H 40 cm •



25845
Fauteuil club Sim blanc
64 x 69 cm H 76 cm •



25689
Fauteuil club Sim noir
64 x 69 cm H 76 cm •



16164
Fauteuil Club
70 x 75 cm H 75 cm

CÔNE



18080
Pouf rond houssé noir
Ø 50 cm H 45 cm •

18732
Banquette houssée noire
50 x 150 cm H 40 cm •



18083
Pouf rond houssé rouge
Ø 50 cm H 45 cm •

18734
Banquette houssée rouge
50 x 150 cm H 40 cm •



1

2

21423
1 | Module central Cône blanc
75 x 75 cm H 75 cm
(ou fauteuil individuel)
21427
2 | Table basse Cône blanc avec plateau
acrylique blanc 70 x 70 cm H 40 cm



1

2

21410
1 | Module central Cône noir
75 x 75 cm H 75 cm
(ou fauteuil individuel)
21414
2 | Table basse Cône noir avec plateau
acrylique blanc 70 x 70 cm H 40 cm

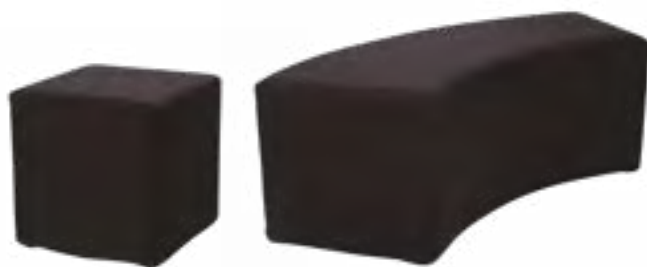

25696
Pouf carré vinyle noir
40 x 40 cm H 40 cm •

25700
Banquette arrondie vinyle noir
50 x 150 cm H 40 cm •



25695
Pouf carré vinyle blanc
40 x 40 cm H 40 cm •

25699
Banquette arrondie vinyle blanc
50 x 150 cm H 40 cm •



21424
Module d'angle Cône blanc
75 x 75 cm H 75 cm



21411
Module d'angle Cône noir
75 x 75 cm H 75 cm



28450
Module d'angle Cône gris
75 x 75 cm H 75 cm



28608
Module central Cône gris
75 x 75 cm H 75 cm

MOBILIER LOUNGE ET CANAPÉS

LALISSE



28445
Fauteuil Lalisse blanc
84 x 122 cm H 89 cm

28447
Table basse Lalisse blanche
73 x 106 cm H 76 cm

28446
Canapé Lalisse blanc
82 x 183 cm H 84 cm

TRESSÉ GRIS



25692
Fauteuil Lounge
tressé gris
80 x 80 cm H 67 cm

25892
Table basse carrée
Lounge tressé
80 x 80 cm H 20 cm

25691
Canapé deux places
Lounge tressé gris
80 x 160 cm H 67 cm

COCOON



25901
Canapé 2 places Cocoon
80 x 170 cm H 75 cm
Alimentation autonome

 Couleurs programmables
avec une télécommande



25690
Canapé trois places
Lounge tressé gris
80 x 240 cm H 67 cm





25693
Module central
Lounge tressé gris
80 x 80 cm H 67 cm

POOL



25909
Fauteuil Lounge Pool blanc
76 x 90 cm H 68 cm • 

25908
Canapé Lounge Pool blanc
90 x 160 cm H 68 cm • 

25910
Banquette Lounge Pool blanc
40 x 80 cm H 30 cm • 

25911
Table basse Lounge Pool blanc
40 x 80 cm H 30 cm (avec plaque plexi) • 



26393
Cousin Saint Petersburg
40 x 65 cm



26391
Cousin chintz blanc
40 x 65 cm



27191
Module d'angle de mobilier
Lounge tressé gris
80 x 80 cm H 67 cm
(droite et gauche)



25891
Table basse rectangulaire
Lounge tressé
65 x 55 cm H 40 cm



25694
Pouf Lounge tressé gris
80 x 80 cm H 40 cm

 Le mobilier Pool est idéal pour une utilisation en extérieur car son revêtement résiste à l'eau.



MOBILIER LOUNGE ET CANAPÉS

GREY



25681
Canapé 2 places Lounge Grey
76 x 204 cm H 70 cm



25683
Table basse Lounge
70 x 140 cm H 16 cm



25812
Banquette Lounge Grey
70 x 140 cm H 36 cm



26409
Fauteuil Lounge Grey
76 x 76 cm H 70 cm



25682
Module d'angle Lounge Grey
76 x 76 cm H 70 cm
(droite et gauche)



26410
Pouf Lounge Grey
76 x 76 cm H 36 cm

IBIZA



28563
Canapé Lounge Ibiza
76 x 204 cm H 70 cm



28565
Banquette Lounge Ibiza
70 x 140 cm H 36 cm



25683
Table basse Lounge
70 x 140 cm H 16 cm



28569
Fauteuil Lounge Ibiza
76 x 76 cm H 70 cm



28567
Module d'angle Lounge Ibiza
76 x 76 cm H 70 cm

(i) Le tissu de l'ensemble Grey est déperlant.

BEACH CLUB BLUE



35725
Canapé Lounge Beach Club Blue
76 x 204 cm H 70 cm



35736
Banquette Lounge Beach Club Blue
70 x 140 cm H 36 cm



35722
Fauteuil Lounge Beach Club Blue
76 x 76 cm H 70 cm



35737
Module d'angle Lounge Beach Club Blue
76 x 76 cm H 70 cm



35738
Pouf Lounge Beach Club Blue
76 x 76 cm H 36 cm

KATMANDOU



28564
Canapé Lounge Katmandou
76 x 204 cm H 70 cm



28566
Banquette Lounge Katmandou
70 x 140 cm H 36 cm



28570
Fauteuil Lounge Katmandou
76 x 76 cm H 70 cm



28568
Module d'angle Lounge Katmandou
76 x 76 cm H 70 cm



MOBILIER LOUNGE ET CANAPÉS

BALI



34421
Fauteuil Bali
70 x 75 cm H 80 cm

34424
Canapé Bali rayé gris
70 x 180 cm H 80 cm

34428
Table basse Bali
60 x 90 cm H 48 cm

34427
Pouf Bali
Ø 40 cm H 40 cm

ROMANCE



27102
Pouf Romance
55 x 65 cm H 44 cm

27069
Canapé 2 places Romance
78 x 162 cm H 80 cm

27108
Table basse Romance
55 x 110 cm H 40 cm

27080
Fauteuil Romance
70 x 72 cm H 95 cm

i Le tissu de l'ensemble Romance est déperlant.

BIARRITZ



35733
Canapé Biarritz
70 x 190 cm H 78 cm

35732
Fauteuil Biarritz
70 x 75 cm H 78 cm

GALET BEIGE



35422
Banc Galet beige
60 x 100 cm H 40 cm

35421
Pouf Galet beige
38 x 50 cm H 41 cm

ELTON TAUPE



35423
Canapé velours Elton taupe
78 x 170 cm H 70 cm

35420
Fauteuil velours Elton taupe
78 x 90 cm H 70 cm

35693
Table basse gigogne filaire or
Ø 60/70 cm H 31/34 cm



35655
Canapé velours Elton taupe avec réhausse
78 x 170 cm H 80 cm

35654
Fauteuil velours Elton taupe avec réhausse
78 x 90 cm H 80 cm



MOBILIER LOUNGE ET CANAPÉS

LOFT GRIS



27088
Pouf Loft gris
80 x 80 cm H 40 cm

27085
Canapé deux places Loft gris
80 x 196 cm H 73 cm
27105
Table basse bois
60 x 110 cm H 35 cm

27086
Fauteuil Loft gris
80 x 98 cm H 73 cm
27087
Pouf Loft gris
40 x 80 cm H 40 cm

CHESTERFIELD



16316
Canapé Chesterfield argent
92 x 202 cm H 76 cm



16317
Fauteuil Chesterfield argent
75 x 82 cm H 75 cm



16320
Pouf Chesterfield argent
44 x 44 cm H 42 cm



16321
Table basse Chesterfield argent
44 x 44 cm H 42 cm

CLUB CUIR



27079
Fauteuil Club cuir marron
83 x 100 cm H 87 cm

27068
Canapé 2 places Club cuir marron
83 x 190 cm H 87 cm
27105
Table basse bois
60 x 110 cm H 35 cm



16048
Canapé Chesterfield blanc
92 x 202 cm H 76 cm



16049
Fauteuil Chesterfield blanc
75 x 82 cm H 75 cm



16050
Pouf Chesterfield blanc
44 x 44 cm H 42 cm



16240
Table basse Chesterfield blanche
44 x 44 cm H 42 cm

MOBILIER LOUNGE ET CANAPÉS

JULIETTE



29976
Fauteuil Juliette aubergine
78 x 84 cm H 85 cm



29975
Canapé Juliette aubergine
78 x 165 cm H 85 cm
29982
Table basse Filor
Ø 64 cm H 35 cm



29977
Pouf Juliette aubergine
Ø 35 cm H 44 cm



29973
Fauteuil Juliette bleu vert
78 x 84 cm H 85 cm



29972
Canapé Juliette bleu vert
78 x 165 cm H 85 cm
29982
Table basse Filor
Ø 64 cm H 35 cm



29974
Pouf Juliette bleu vert
Ø 35 cm H 44 cm



29978
Pouf Juliette jaune moutarde
Ø 35 cm H 44 cm



29980
Pouf Juliette vert
Ø 35 cm H 44 cm



29979
Pouf Juliette vieux rose
Ø 35 cm H 44 cm



30825
Coussin Juliette jaune moutarde 40 x 40 cm
30826
Coussin Juliette vert 40 x 40 cm
30827
Coussin Juliette vieux rose 40 x 40 cm

MODULO



35709
Canapé Lounge Modulo

Composition de l'ensemble :
2 poufs 60 x 80 cm H 40 cm - 1 pouf 80 x 120 cm H 40 cm - 1 dossier 30 x 80 cm H 60 cm -
1 dossier 30 x 120 cm H 60 cm - 1 table d'appoint 30 x 60 cm H 40 cm





TABLES BASSES



25683
Table basse Lounge
70 x 140 cm H 16 cm



27105
Table basse bois
60 x 110 cm H 35 cm



27108
Table basse Romance
55 x 110 cm H 40 cm



34428
Table basse Bali
60 x 90 cm H 48 cm



25911
Table basse Lounge Pool blanc
40 x 80 cm H 30 cm
(avec plaque plexi) •



Plateau réversible

29982
Table basse Filor
Ø 64 cm H 35 cm



35693
Table basse gigogne filaire or
Ø 60/70 cm H 31/34 cm



28509
Table basse croisée acier plateau noir
64 x 101 cm H 35 cm



28506
Table basse croisée blanche plateau noir
64 x 101 cm H 35 cm



28507
Table basse croisée acier plateau bois
64 x 101 cm H 35 cm



28504
Table basse croisée blanche plateau bois
64 x 101 cm H 35 cm

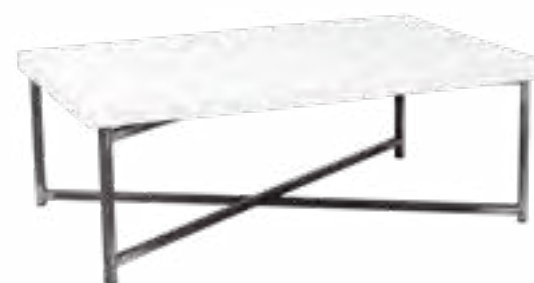

28508
Table basse croisée acier plateau blanc
64 x 101 cm H 35 cm

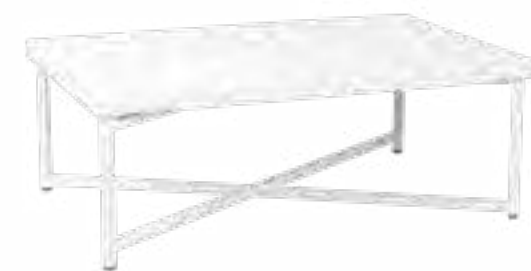

28505
Table basse croisée blanche plateau blanc
64 x 101 cm H 35 cm



TABLES BASSES



19524
Table basse noire
55 x 55 cm H 45 cm



18877
Table basse blanche
55 x 55 cm H 45 cm



27104
Table basse Hobby noire
Ø 60 cm H 40 cm



27103
Table basse Hobby blanche
Ø 60 cm H 40 cm



21427
Table basse Cône blanc plateau
acrylique blanc 70 x 70 cm H 40 cm



21414
Table basse Cône noir plateau
acrylique blanc 70 x 70 cm H 40 cm
23093
Kit lumineux pour mobilier Cône blanc



27186
Table basse Cône noir plateau acrylique
noir 70 x 70 cm H 40 cm
23096
Kit lumineux pour table basse Cône noir



25892
Table basse carrée
Lounge tressé
80 x 80 cm H 20 cm



25891
Table basse rectangulaire
Lounge tressé
55 x 65 cm H 40 cm



16321
Table basse Chesterfield
argent 44 x 44 cm H 42 cm



16240
Table basse Chesterfield
blanche 44 x 44 cm H 42 cm



26203
Table basse lumineuse Coney
Ø 60 cm H 45 cm
Alimentation autonome

Couleurs programmables
avec une télécommande



25900
Table basse lumineuse Rondy
Ø 66 cm H 37 cm
Alimentation autonome

Couleurs programmables
avec une télécommande



25701
Pouf lumineux
40 x 40 cm H 40 cm
Alimentation autonome

Couleurs programmables
avec une télécommande

MANGE-DEBOUT



28470
Mange-debout croisé acier plateau bois
65 x 65 cm H 90 cm

28471
Mange-debout croisé acier plateau bois
65 x 65 cm H 100 cm

28472
Mange-debout croisé acier plateau bois
65 x 65 cm H 110 cm



28488
Mange-debout croisé acier plateau noir
65 x 65 cm H 90 cm

28489
Mange-debout croisé acier plateau noir
65 x 65 cm H 100 cm

28490
Mange-debout croisé acier plateau noir
65 x 65 cm H 110 cm



28479
Mange-debout croisé acier plateau blanc
65 x 65 cm H 90 cm

28480
Mange-debout croisé acier plateau blanc
65 x 65 cm H 100 cm

28481
Mange-debout croisé acier plateau blanc
65 x 65 cm H 110 cm



28467
Mange-debout croisé blanc plateau bois
65 x 65 cm H 90 cm

28468
Mange-debout croisé blanc plateau bois
65 x 65 cm H 100 cm

28469
Mange-debout croisé blanc plateau bois
65 x 65 cm H 110 cm



28485
Mange-debout croisé blanc plateau noir
65 x 65 cm H 90 cm

28486
Mange-debout croisé blanc plateau noir
65 x 65 cm H 100 cm

28487
Mange-debout croisé blanc plateau noir
65 x 65 cm H 110 cm



28476
Mange-debout croisé blanc plateau blanc
65 x 65 cm H 90 cm

28477
Mange-debout croisé blanc plateau blanc
65 x 65 cm H 100 cm

28478
Mange-debout croisé blanc plateau blanc
65 x 65 cm H 110 cm



34447
Mange-debout croisé or plateau noir
65 x 65 cm H 100 cm



MANGE-DEBOUT



12710
Mange-debout acier carré
60 x 60 cm H 111 cm •



20894
Mange-debout acier rond
Ø 60 cm H 111 cm



25704
Mange-debout plateau bois
80 x 80 cm H 111 cm



16251
Mange-debout acier
carré houssé blanc
60 x 60 cm H 111 cm •



16252
Mange-debout acier
carré houssé noir
60 x 60 cm H 111 cm •



16253
Mange-debout acier
carré houssé fuchsia
60 x 60 cm H 111 cm •



24346
Mange-debout acier
carré houssé bleu
60 x 60 cm H 111 cm •



21436
Mange-debout Cône blanc
plateau acrylique blanc
70 x 70 cm H 110 cm



21421
Mange-debout Cône noir
plateau acrylique blanc
70 x 70 cm H 110 cm



27309
Mange-debout Cône noir
plateau acrylique noir
70 x 70 cm H 110 cm

Couleurs programmables
avec une télécommande



23093
Kit lumineux pour mobilier Cône blanc

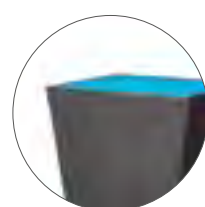

23094
Kit lumineux pour mange-debout Cône noir



24347
Mange-debout acier
carré houssé gris
60 x 60 cm H 111 cm •



16254
Mange-debout acier
carré houssé rouge
60 x 60 cm H 111 cm •



16255
Mange-debout acier
carré houssé turquoise
60 x 60 cm H 111 cm •



19287
Mange-debout acier
carré houssé argent
60 x 60 cm H 111 cm



19288
Mange-debout acier
carré houssé or
60 x 60 cm H 111 cm



28596
Mange-debout acier
carré houssé beige
60 x 60 cm H 111 cm •



29079
Mange-debout acier
rond houssé noir
Ø 60 cm H 110 cm •



29080
Mange-debout acier
rond houssé blanc
Ø 60 cm H 110 cm •



21434
Mange-debout vasque Cône blanc
70 x 70 cm H 110 cm



21419
Mange-debout vasque Cône noir
70 x 70 cm H 110 cm

MANGE-DEBOUT



26461
Mange-debout Icône blanc
Ø 69 cm H 106 cm
25703
Mange-debout Icône lumineux
Ø 69 cm H 106 cm

 Couleurs programmables
avec une télécommande



29987
Mange-debout Icône noir
Ø 69 cm H 106 cm



27094
Mange-debout Romance
Ø 67 cm H 113 cm



27180
Mange-debout Gigogne blanc et gris
(ensemble de 3)
50 x 50 cm H 95 cm
50 x 60 cm H 105 cm
50 x 70 cm H 115 cm



27310
Mange-debout Cube blanc et gris
(ensemble de 4)
45 x 45 cm H 110 cm
52 x 52 cm H 114 cm



31027
Mange-debout Cap Ferret
60 x 60 cm H 115 cm



Découvrez également le buffet
assorti page 52.



31033
Mange-debout Palissade Pacific
60 x 60 cm H 115 cm



Découvrez également le buffet
assorti page 52.



31028
Mange-debout Deck
60 x 60 cm H 115 cm



Découvrez également le buffet
assorti page 51.



20920
Mange-debout cylindres
blancs housés (par 3)
Ø 41 cm H 110 cm
Ø 47 cm H 112 cm
Ø 53 cm H 114 cm



20921
Mange-debout cylindres
noirs housés (par 3)
Ø 41 cm H 110 cm
Ø 47 cm H 112 cm
Ø 53 cm H 114 cm



31029
Mange-debout Mandarin
60 x 60 cm H 115 cm



Découvrez également le buffet
assorti page 52.



19582
Tonneau fermé
L 80 cm H 95 cm



24126
Tonneau ouvert
L 80 cm H 95 cm



16309
Mange-debout Luciole
Ø 91 H 116 cm
Alimentation autonome



17971
Mange-debout Palladium
Ø 91 cm H 118 cm
Alimentation autonome

TERRASSE ET JARDIN



20897
Parasol Louisiane
rouge vif 300 x 300 cm
+ socle acier 30 x 30 cm
20898
Parasol Louisiane
rouge vif 300 x 300 cm
+ socle granit Ø 50 cm

20899
Parasol Louisiane
noir 300 x 300 cm
+ socle acier 30 x 30 cm
20900
Parasol Louisiane
noir 300 x 300 cm
+ socle granit Ø 50 cm

11453
Parasol Louisiane
taupe 300 x 300 cm
+ socle acier 30 x 30 cm
11922
Parasol Louisiane
taupe 300 x 300 cm
+ socle granit Ø 50 cm

1005
Parasol Louisiane
écru 300 x 300 cm
+ socle acier 30 x 30 cm
11921
Parasol Louisiane
écru 300 x 300 cm
+ socle granit Ø 50 cm

ⓘ Le socle acier ne s'utilise qu'avec des tables type Louisiane et Wood. Le socle granit peut s'utiliser seul.



25706
Eclairage autonome
pour parasol



Socle granit
Ø 50 cm



36056
Parasol Biarritz
Ø 210 cm H 260 cm
+ socle granit Ø 50 cm



136
Parasol blanc Ø 180 cm
313
Socle de parasol
plastique blanc Ø 43 cm



30155
Tente Garden 300 x 300 cm sans murs
(avec rideaux caches pied)
10218
Tente Garden 300 x 300 cm avec murs
(comprend 3 murs pleins et 1 mur porte)
30157
Tente Garden 400 x 400 cm sans murs
(avec rideaux caches pied)
30156
Tente Garden 400 x 400 cm avec murs
(comprend 2 murs fenêtre, 1 mur plein et 1 mur porte)



15321
Ibiza Lounge - matelas 200 x 200 cm
et pergola avec voilages

ⓘ Livrés sans les poufs et la table basse



10782
Tente Octogonale Ø 12 m

ⓘ Hauteur du mât central : 5 m - Hauteur des poteaux : 2 m



24352
Pergola avec toit voilage
300 x 300 cm H 280 cm



15315
Pergola
300 x 300 cm H 300 cm



1107
Barrière blanche Vincennes 200 cm H 110 cm
hors montage



TERRASSE ET JARDIN



35818
Transat Biarritz L 93 cm



24544
Transat blanc L 94 cm



22148
Transat fuchsia L 94 cm



22116
Transat turquoise L 94 cm



22127
Transat vert anis L 94 cm



139
Torche à pétrole
H 110 cm
+ 50 cl Kerdane



27115
Torche Nomade bois naturel
Ø 50 cm H 175 cm avec bougie
26876
Bougie recharge
pour torche Nomade
(autonomie 9h) • *



27099
Photophore d'extérieur fer forgé H 60 cm
27100
Photophore d'extérieur fer forgé H 90 cm
26878
Bûche d'ambiance Ø 13 cm H 24 cm
(autonomie 3 à 4 h) • *



34968
Lanterne acier noir
15 x 15 cm H 28 cm



9939
Lanterne Exo
27 x 27 cm H 70 cm
+ bougie 3 mèches



27084
Lanterne Exo
23 x 23 cm H 72 cm
+ bougie 3 mèches



13722
Lanterne marocaine grand modèle
30 x 30 cm H 80 cm *
16372
Lanterne marocaine moyen modèle
18 x 18 cm H 45 cm *
* Louée sans bougie



27065
Brasero Ø 60 cm H 35 cm
(livré avec un filet de bûches)
26877
Bûche 30 cm en filet
(pour brasero) • *



27113
Torche en pot
Ø 12 cm H 11 cm
(autonomie 10 h) • *



22778
Chauffage de terrasse
inox H 240 cm gaz



18476
Chauffage de terrasse Pyramide
acier H 230 cm gaz propane



27185
Chauffage de terrasse Pyramide
noir H 230 cm gaz propane



27195
Chauffage de terrasse
électrique H 167 cm
900/1800 W ou 2700 W



20862
Arc en ciel chauffant
sur alimentation + variateur



19429
Chauffage électrique
3000 W



1304
Aérotherme
12000 W triphasé

Les chauffages de terrasse au gaz sont livrés avec une bouteille de gaz.



PARAVENTS, CLOISONS, VESTIAIRES ET MAQUILLAGE



4581
Paravent Louisiane
2 feuilles
L 130 cm (65 cm x 2) H 205 cm



26608
Paravent Louisiane gris acier
2 feuilles
L 130 cm (65 cm x 2) H 205 cm



26607
Paravent Louisiane noir
2 feuilles
L 130 cm (65 cm x 2) H 205 cm

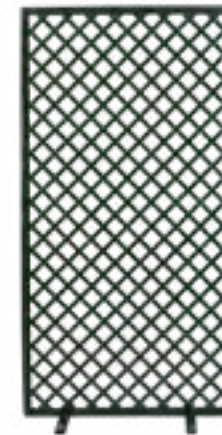

13254
Claustra en treillage vert
L 100 cm H 200 cm



19324
Cloison couchée aluminium L 201 cm H 102 cm
 Habillage coloris au choix page 46



18018
Cloison alu sur pied L 102 cm H 201 cm
 Habillage coloris au choix page 46



15112
Paravent black and white 3 feuilles
L 210 cm (70 cm x 3) H 186 cm
1 face noire, 1 face blanche



30842
Paravent Beverly
(65 cm x 3) H 186 cm
1 face noire et or, 1 face blanche et or



18019
Cloison assemblée 3 feuilles
L 306 cm (102 cm x 3) H 201 cm
 Habillage coloris au choix page 46



20923
Cloison autoportante grise
L 320 cm H 260 cm •



25705
Paravent plexi 3 feuilles
L 210 (70 cm x 3) H 186 cm •



28581
Paravent opaque 3 feuilles
L 210 (70 cm x 3) H 186 cm •



13926
Paravent Laméco gris
L 180 cm H 180 cm



29192
Psyché couture
H 160 cm l 45 cm



29191
Psyché couture noir
H 160 cm l 45 cm



325
Perroquet en bois noir
H 185 cm



34438
Ventilateur à poser
Ø 40 cm l 48 cm H 45 cm

PARAVENTS, CLOISONS, VESTIAIRES ET MAQUILLAGE



048
Vestiaire L 200 cm H 175 cm
+ 50 cintres + 1 carnet



3048
Vestiaire couture L 150 cm H 177 cm
+ 50 cintres + 1 carnet

i Le porte-parapluie peut être fixé au vestiaire couture réf. 3048.

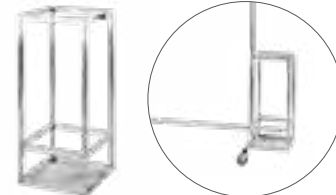

27015
Porte-parapluie
31,5 x 31,5 cm H 71,5 cm



1124
Chevalet bois
L 58 cm H 150 cm



2004
Écran de projection
180 x 180 cm



1309
Lampe halogène
3000 W



11113
Tableau de conférence
291
Tableau de conférence
avec recharge
292
Recharge tableau
de conférence • (*)
29700
Feutre effaçable noir • (*)



24331
Fontaine à eau 18,9 L
+ 200 gobelets
230 V / 120 W
24276
Bonbonne à eau • (*)
30930
Lot de 100 gobelets
kraft 18 cl • (*)
30931
Lot de 50 gobelets
kraft 23 cl • (*)



050
Carnet de vestiaire
50 tickets



049
Cintre chrome



11672
Serviette éponge
30 x 30 cm



23087
Panier à serviettes
32 x 52 cm
Serviettes non fournies



32812
Défroisseur à vapeur
220 V



393
Manne osier avec sangles
40 x 60 cm



17978
Poubelle
H 30 cm Ø 29 cm



1293
Poubelle en osier
avec couvercle H 60 cm Ø 35 cm



19360
Sono : 1 enceinte + 2 micros
+ 2 pieds de micro



30154
Vidéoprojecteur avec
télécommande



12935
Combiné de maquillage
L 92 cm P 60 cm H 132 cm



20599
Valise maquillage
i Fermée L 55 P 51 H 19 cm
Ouverte L 50 P 44,5 H 58 cm
Hauteur des pieds 82 cm



27200
Miroir maquillage
60 x 65 cm



1114
Estrade 100 x 100 cm H 25 cm
135
Estrade 100 x 200 cm H 25 cm
285
Estrade 100 x 200 cm H 50 cm
521
Marche estrade H 25 cm

i Habillage moquette grise



36299
M² de podium H 20 cm - coloris plateau et façade au choix
36300
M² de podium H 40 cm - coloris plateau et façade au choix
15533
Marche H 20 cm avec habillage

i Habillage moquette couleurs au choix
Habillage façade : coton gratté au choix page 47



ACCUEIL, ACCESSOIRES CONFÉRENCE



9909
Pupitre plexi
40 x 50 cm H 120 cm



21644
Pupitre Light
62 x 62 cm H 120 cm



1106
Pupitre Design
50 x 70 cm H 120 cm



27097
Panneau grille sur pieds
Surface d'affichage 122 x 172 cm
Hauteur totale 185 cm



27098
Panneau liège 2 faces sur pieds
Surface d'affichage 122 x 172 cm
Hauteur totale 185 cm



10002
Panneau pied blanc
format 30 x 40 cm
H 90 à 150 cm
10003
Panneau pied blanc
format 40 x 50 cm
H 90 à 150 cm



17660
Panneau pied noir
format 30 x 40 cm
H 90 à 150 cm
17744
Panneau pied noir
format 40 x 50 cm
H 90 à 150 cm



498
Panneau de direction
pied blanc (gauche)
H 100 cm
2011
Panneau de direction
pied blanc (droit)
H 100 cm



18129
Potelet d'information
format A4 H 110 cm



18125
Mini potelet d'exposition
H 40 cm
18126
Mètre linéaire de corde élastique
blanche pour mini potelet



10154
Potelet indicateur
format A4 H 130 cm



20814
Potelet acier H 100 cm
20815
Corde noire L 200 cm



492
Potelet doré H 100 cm
493
Corde bordeaux L 200 cm



21337
Potelet enrouleur
L max 200 cm H 97 cm



27101
Présentoir
5 niveaux format A4
H 150 cm



11153
Urne plexiglas
32 x 32 x 34 cm
H 150 cm



33130
Colonne distributeur à
pédale + bidon d'1L de gel
hydroalcoolique
33129
Bidon d'1L de
gel hydroalcoolique *



133
Cendrier sur pied
Ø 19 cm H 70 cm



25707
Cendrier sur pied Klop H 71 cm
haut 7 x 7 cm - base 18 x 18 cm



19290
Cendrier sur pied avec poubelle
Ø 24 cm H 70 cm

MOQUETTE, PISTES DE DANSE ET ÉCLAIRAGE



21104
M² de dalle de moquette gris chiné sans pose
21105
M² de dalle de moquette gris chiné avec pose



10480
M² moquette "aiguilleté" avec pose
Couleurs au choix



11123
M² de tapis Foxsol (anti dérapant)



20912
Dalle caillebotis bois
95 x 95 cm



10714
M² de piste de danse bois avec pose (intérieur)

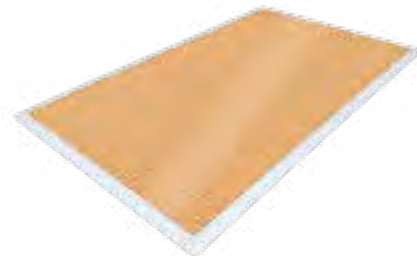

34404
Plancher - piste de danse intérieur et extérieur
15m² plancher 3m x 5m
Différentes dimensions disponibles sur demande



20081
M² de piste de danse lackfolie; 0 à 10 m²
20127
M² de piste de danse lackfolie; 11 à 25 m²
20128
M² piste de danse lackfolie; 26 à 50 m²
20129
M² piste de danse lackfolie; + de 51m²

Nuancier des coloris disponibles page 46



11200
M² polyane noir/blanc ignifugé, avec pose ; 3 m de large



1312
Boîte noire 300 W (hors montage)



1311
Boîte noire 150 W (hors montage)



20913
Cache noir pour boîte noire 27 x 28 x 29 cm



14160
Cache blanc pour boîte noire 27 x 28 x 29 cm



19076
Boîte noire autonome avec programmeur de couleurs



27195
Guirlande lumineuse ampoules filaments 5 m prolongeable (maximum 8)



21792
Guirlande lumineuse multicolore 9 m

LUMINAIRES



28438
Lot de 2 lampadaires multidirectionnels blancs H 230 cm
Alimentation autonome



28431
Lampadaire Maouse 60 x 80 cm H 180 cm



25714
Cylindre lumineux Ø 30 cm H 160 cm
25713
Cylindre lumineux Ø 30 cm H 106 cm
25712
Cylindre lumineux Ø 20 cm H 60 cm
Alimentation autonome

Couleurs programmables avec une télécommande

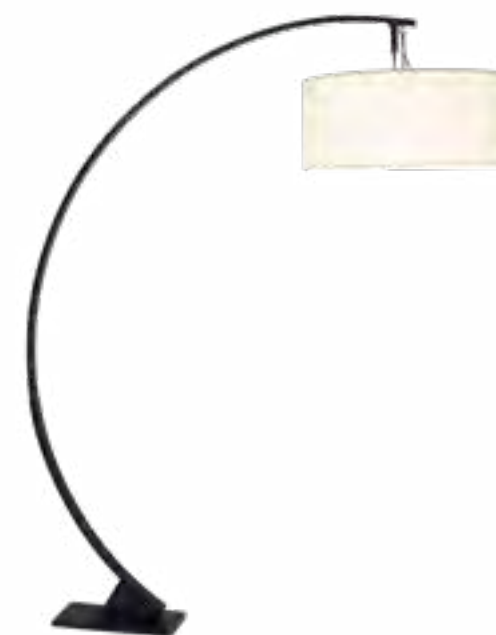

20865
Arc en Ciel abat-jour sur alimentation (220 V) + variateur

21318
Arc en Ciel abat-jour sur batterie (autonomie 6h)
Abat-jour personnalisation sur demande

Dimensions :
H depuis le sol : 234 cm
Rayon : 129 cm



20864
Arc en Ciel avec spots sur alimentation (220 V) + variateur
20863
Arc en Ciel avec spots sur batterie (autonomie 6h)



21320
Arc en Ciel avec lustre 8 sphères sur batterie (autonomie 5h)

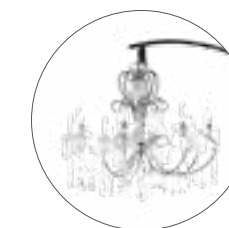



20907
Arc en ciel lustre sur alimentation (220 V) + variateur



NAPPAGE

Nappes et serviettes	118
Gazes de coton, molletons et feutrines.....	146
Textiles et toiles cirées	148

 : Classé au feu

 : Origine France

 : Origine Union Européenne

NAPPES ET SERVIETTES

GAMME STANDARD ★☆☆☆

Coton blanc
page 120

Vichy
page 120

Bleu intense • 
page 121

Marjorie beige • 
page 124

Marjorie bleu • 
page 124

Marjorie gris • 
page 124

Marjorie anthracite • 
page 124

Marjorie rouge • 
page 124

Marjorie Terracotta • 
page 125

Marjorie vert • 
page 125

Marjorie jaune • 
page 125

Marjorie noir • 
page 125

Chintz blanc • 
page 126

Chintz beige • 
page 126

Chintz gris souris • 
page 126

Chintz noir • 
page 126

Chintz rouge • 
page 127

Chintz orange
page 127

Chintz parme
page 127

Chintz vert amande
page 127

Chintz bleu océan
page 127

Bagatelle
page 130

Séville blanc
page 130

Biarritz
page 130

Davos
page 130

Saint-Pétersbourg
page 131

GAMME ÉLÉGANCE ★★☆☆

Coton blanc uni Alaska
page 121

Venise ivoire
page 121

Or • 
page 131

Dubaï doré
page 131

Dubaï cuivré
page 131

Toscane bleu nuit
page 134

Toscane grenade
page 134

Toscane bronze
page 134

Toscane mandarine
page 134

Toscane acier
page 134

Toscane chocolat
page 135

Toscane cassis
page 135

Toscane taupe
page 135

Toscane rouge opéra
page 135

Toscane cuivre
page 135

Lin blanc
page 138

Lin bleu
page 138

Lin rose
page 138

Lin gris
page 138

Lin corail
page 138

Lin chaume
page 139

Lin ficelle
page 139

Lin rouge
page 139

Lin vert
page 139

Delhi champagne • 
page 142

Delhi fuchsia • 
page 142

Delhi prune • 
page 142

Delhi vert céladon • 
page 142

Toile de Jouy brique
page 143

Toile de Jouy bleu
page 143

Toile de Jouy vert
page 143

GAMME EXCELLENCE ★★★★

Nappe imprimée sur-mesure
page 143

NAPPES ET SERVIETTES

GAMME STANDARD ★☆☆☆



COTON BLANC

- 096 • Nappe 120 x 120 cm
- 070 • Nappe 150 x 150 cm
- 060 • Nappe 150 x 250 cm
- 071 • Nappe 180 x 180 cm
- 061 • Nappe 180 x 300 cm
- 062 • Nappe 180 x 350 cm
- 068 • Nappe 210 x 1000 cm
- 069 • Nappe 210 x 1200 cm
- 072 • Nappe 210 x 210 cm
- 063 • Nappe 210 x 400 cm
- 064 • Nappe 210 x 500 cm
- 065 • Nappe 210 x 600 cm
- 067 • Nappe 210 x 800 cm
- 814 • Nappe 240 x 1000 cm
- 829 • Nappe 240 x 1200 cm
- 073 • Nappe 240 x 240 cm
- 810 • Nappe 240 x 400 cm
- 811 • Nappe 240 x 500 cm
- 812 • Nappe 240 x 600 cm
- 813 • Nappe 240 x 800 cm
- 486 • Serviette de table 60 x 60 cm

GAMME ÉLÉGANCE ★★☆☆



ALASKA COTON BLANC UNI

- 27001 • Nappe 210 x 210 cm
- 28280 • Nappe 240 x 240 cm
- 26953 • Nappe 290 x 400 cm
- 26954 • Nappe 290 x 500 cm
- 26955 • Nappe 290 x 600 cm
- 26956 • Nappe 310 x 310 cm
- 26884 • Chemin de table 50 x 270 cm
- 27027 • Serviette de table 50 x 50 cm
- 27183 • Set de table 30 x 45 cm



VICHY

- 4066 • Nappe Vichy 150 x 150 cm



VENISE IVOIRE

- 4142 • Nappe 240 x 240 cm
- 4144 • Nappe 280 x 280 cm
- 4145 • Nappe 280 x 500 cm
- 4146 • Nappe 280 x 600 cm
- 4140 • Serviette de table 50 x 50 cm



BLEU INTENSE

- 20834 • Nappe 210 x 210 cm
- 20835 • Nappe 290 x 290 cm
- 20836 • Nappe 290 x 400 cm
- 20838 • Nappe 290 x 600 cm
- 20840 • Chemin de table 50 x 270 cm
- 20841 • Serviette de table 60 x 60 cm

 Les dimensions du nappage peuvent varier de 5% par rapport aux dimensions mentionnées au catalogue.



NAPPES ET SERVIETTES

GAMME ÉLÉGANCE ★★★★☆

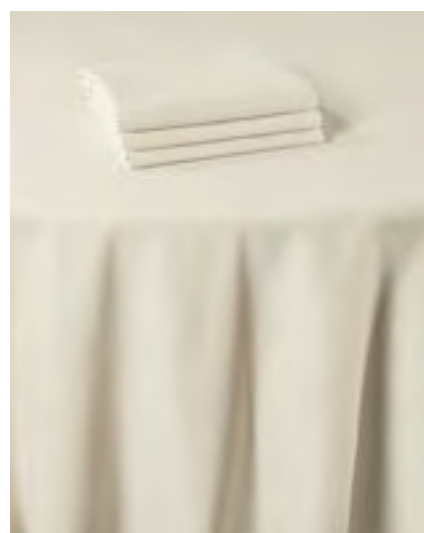

MARJORIE BEIGE •

- 34385 • Nappe 180 x 350 cm
- 26966 • Nappe 210 x 210 cm
- 26968 • Nappe 290 x 400 cm
- 26969 • Nappe 290 x 500 cm
- 26970 • Nappe 290 x 600 cm
- 26967 • Nappe 310 x 310 cm
- 26882 • Chemin de table 50 x 270 cm
- 27029 • Serviette de table 50 x 50 cm



MARJORIE BLEU •

- 34386 • Nappe 180 x 350 cm
- 26973 • Nappe 210 x 210 cm
- 26971 • Nappe 290 x 400 cm
- 26972 • Nappe 290 x 500 cm
- 26975 • Nappe 290 x 600 cm
- 26974 • Nappe 310 x 310 cm
- 26883 • Chemin de table 50 x 270 cm
- 27030 • Serviette de table 50 x 50 cm



MARJORIE GRIS •

- 34387 • Nappe 180 x 350 cm
- 26978 • Nappe 210 x 210 cm
- 26976 • Nappe 290 x 400 cm
- 26977 • Nappe 290 x 500 cm
- 26980 • Nappe 290 x 600 cm
- 26979 • Nappe 310 x 310 cm
- 26885 • Chemin de table 50 x 270 cm
- 27031 • Serviette de table 50 x 50 cm



MARJORIE TERRACOTTA •

- 34391 • Nappe 180 x 350 cm
- 26994 • Nappe 210 x 210 cm
- 26991 • Nappe 290 x 400 cm
- 26992 • Nappe 290 x 500 cm
- 26993 • Nappe 290 x 600 cm
- 26995 • Nappe 310 x 310 cm
- 26888 • Chemin de table 50 x 270 cm
- 27034 • Serviette de table 50 x 50 cm



MARJORIE VERT •

- 34392 • Nappe 180 x 350 cm
- 26996 • Nappe 210 x 210 cm
- 26998 • Nappe 290 x 400 cm
- 26999 • Nappe 290 x 500 cm
- 27000 • Nappe 290 x 600 cm
- 26997 • Nappe 310 x 310 cm
- 26889 • Chemin de table 50 x 270 cm
- 27035 • Serviette de table 50 x 50 cm



MARJORIE GRIS ANTHRACITE •

- 35478 • Nappe 180 x 350 cm
- 25479 • Nappe 210 x 210 cm
- 35481 • Nappe 290 x 400 cm
- 35515 • Nappe 290 x 500 cm
- 35480 • Nappe 290 x 600 cm
- 35482 • Nappe 310 x 310 cm
- 35473 • Serviette de table 50 x 50 cm

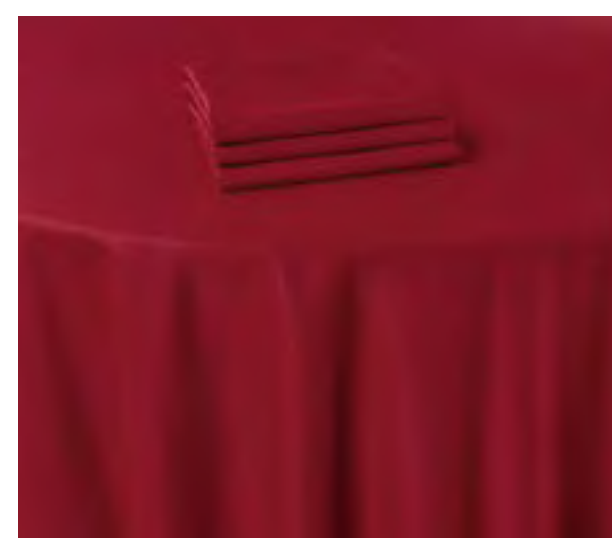

MARJORIE ROUGE •

- 34390 • Nappe 180 x 350 cm
- 26988 • Nappe 210 x 210 cm
- 26986 • Nappe 290 x 400 cm
- 26987 • Nappe 290 x 500 cm
- 26990 • Nappe 290 x 600 cm
- 26989 • Nappe 310 x 310 cm
- 26887 • Chemin de table 50 x 270 cm
- 27033 • Serviette de table 50 x 50 cm



MARJORIE JAUNE •

- 34388 • Nappe 180 x 350 cm
- 26983 • Nappe 210 x 210 cm
- 26981 • Nappe 290 x 400 cm
- 26982 • Nappe 290 x 500 cm
- 26985 • Nappe 290 x 600 cm
- 26984 • Nappe 310 x 310 cm
- 26886 • Chemin de table 50 x 270 cm
- 27032 • Serviette de table 50 x 50 cm



MARJORIE NOIR •

- 34389 • Nappe 180 x 350 cm
- 30644 • Nappe 210 x 210 cm
- 30645 • Nappe 290 x 400 cm
- 30646 • Nappe 290 x 600 cm
- 30647 • Nappe 310 x 310 cm
- 30649 • Chemin de table 50 x 270 cm
- 30648 • Serviette de table 50 x 50 cm

NAPPES ET SERVIETTES

GAMME ÉLÉGANCE ★★★★☆



CHINTZ BLANC •

- 13941 • Nappe 210 x 210 cm
- 13942 • Nappe 290 x 290 cm
- 13943 • Nappe 290 x 400 cm
- 13944 • Nappe 290 x 500 cm
- 13945 • Nappe 290 x 600 cm
- 13946 • Nappe 290 x 800 cm
- 26394 • Nappe 310 x 310 cm
- 14113 • Chemin de table 50 x 270 cm
- 13947 • Serviette de table 60 x 60 cm



CHINTZ BEIGE •

- 4053 • Nappe 180 x 180 cm
- 4054 • Nappe 210 x 210 cm
- 4056 • Nappe 210 x 350 cm
- 4055 • Nappe 240 x 240 cm
- 4061 • Nappe 270 x 1000 cm
- 4062 • Nappe 270 x 270 cm
- 4057 • Nappe 270 x 400 cm
- 4058 • Nappe 270 x 500 cm
- 4059 • Nappe 270 x 600 cm
- 4060 • Nappe 270 x 800 cm
- 26395 • Nappe 310 x 310 cm
- 10086 • Chemin de table 50 x 270 cm
- 4050 • Serviette de table 60 x 60 cm



CHINTZ GRIS SOURIS •

- 10164 • Nappe 210 x 210 cm
- 9976 • Nappe 270 x 270 cm
- 9977 • Nappe 270 x 400 cm
- 9979 • Nappe 270 x 600 cm
- 9980 • Nappe 270 x 800 cm
- 10085 • Chemin de table 50 x 270 cm
- 9981 • Serviette de table 60 x 60 cm



CHINTZ NOIR •

- 4072 • Nappe 180 x 180 cm
- 4073 • Nappe 210 x 210 cm
- 4074 • Nappe 240 x 240 cm
- 4069 • Nappe 270 x 270 cm
- 4075 • Nappe 270 x 400 cm
- 4076 • Nappe 270 x 500 cm
- 4077 • Nappe 270 x 600 cm
- 4078 • Nappe 270 x 800 cm
- 26411 • Nappe 310 x 310 cm
- 10080 • Chemin de table 50 x 270 cm
- 4070 • Serviette de table 60 x 60 cm

GAMME ÉLÉGANCE ★★★★☆



CHINTZ ROUGE •

- 10160 • Nappe 210 x 210 cm
- 9940 • Nappe 240 x 240 cm
- 9941 • Nappe 270 x 270 cm
- 9942 • Nappe 270 x 400 cm
- 9943 • Nappe 270 x 500 cm
- 9944 • Nappe 270 x 600 cm
- 9945 • Nappe 270 x 800 cm
- 10078 • Chemin de table 50 x 270 cm
- 9946 • Serviette de table 60 x 60 cm



CHINTZ ORANGE

- 11157 • Nappe 210 x 210 cm
- 4200 • Nappe 240 x 240 cm
- 11158 • Nappe 270 x 270 cm
- 11223 • Nappe 270 x 400 cm
- 11224 • Nappe 270 x 500 cm
- 11225 • Nappe 270 x 600 cm
- 11226 • Nappe 270 x 800 cm
- 10079 • Chemin de table 50 x 270 cm
- 4065 • Serviette de table 60 x 60 cm



CHINTZ PARME

- 11173 • Nappe 210 x 210 cm
- 11174 • Nappe 240 x 240 cm
- 11179 • Nappe 270 x 270 cm
- 11175 • Nappe 270 x 400 cm
- 11176 • Nappe 270 x 500 cm
- 11177 • Nappe 270 x 600 cm
- 11178 • Nappe 270 x 800 cm
- 11201 • Chemin de table 50 x 270 cm
- 11180 • Serviette de table 60 x 60 cm



CHINTZ VERT AMANDE

- 10162 • Nappe 210 x 210 cm
- 9961 • Nappe 240 x 240 cm
- 9962 • Nappe 270 x 270 cm
- 9963 • Nappe 270 x 400 cm
- 9964 • Nappe 270 x 500 cm
- 9965 • Nappe 270 x 600 cm
- 9966 • Nappe 270 x 800 cm
- 10082 • Chemin de table 50 x 270 cm
- 9967 • Serviette de table 60 x 60 cm



CHINTZ BLEU OCÉAN

- 10159 • Nappe 210 x 210 cm
- 9947 • Nappe 240 x 240 cm
- 9948 • Nappe 270 x 270 cm
- 9949 • Nappe 270 x 400 cm
- 9950 • Nappe 270 x 500 cm
- 9951 • Nappe 270 x 600 cm
- 9952 • Nappe 270 x 800 cm
- 10083 • Chemin de table 50 x 270 cm
- 9953 • Serviette de table 60 x 60 cm



NAPPES ET SERVIETTES

GAMME EXCLUSIVE
★★★★☆

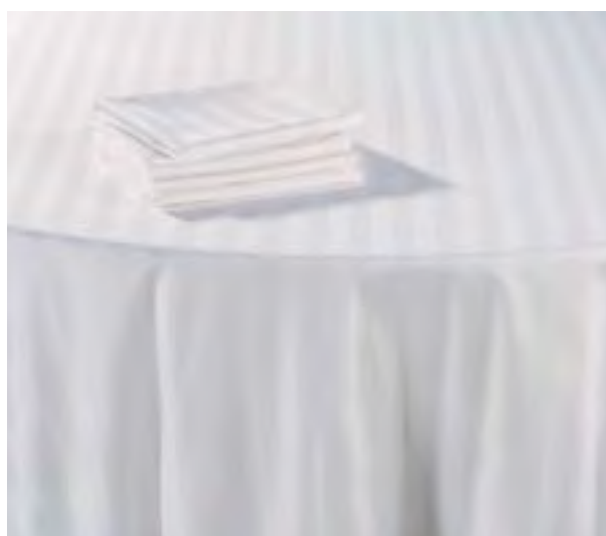

BAGATELLE

9920 • Nappe 290 x 290 cm
9921 • Serviette de table 60 x 60 cm



SÉVILLE BLANC

30040 • Sur-nappe 290 x 290 cm
30041 • Chemin de table 50 x 270 cm

GAMME EXCLUSIVE
★★★★☆

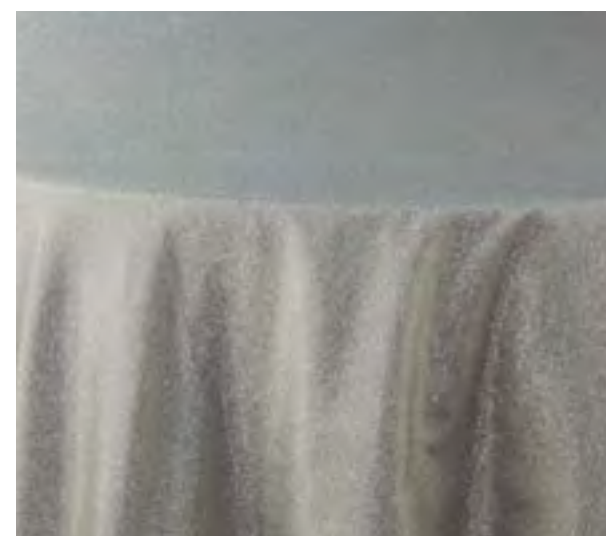

SAINT-PÉTERSBOURG

19960 • Nappe 210 x 210 cm
19961 • Nappe 280 x 280 cm
19959 • Nappe 280 x 400 cm
19958 • Nappe 280 x 500 cm
19957 • Nappe 280 x 600 cm
19956 • Nappe 280 x 800 cm
19962 • Chemin de table 50 x 270 cm

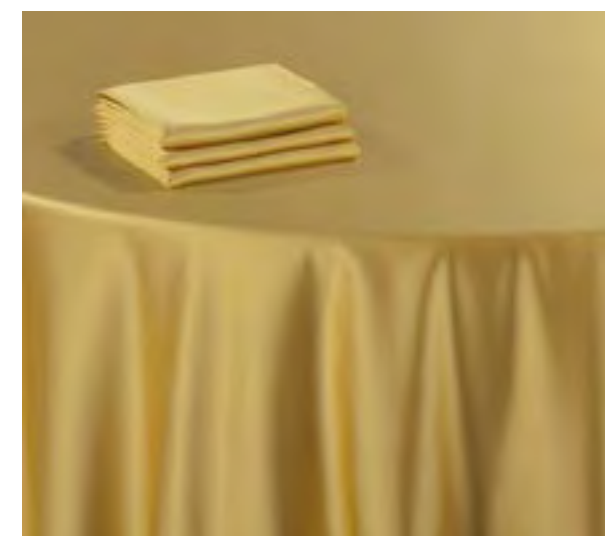

OR •

17999 • Nappe 210 x 210 cm
17998 • Nappe 280 x 280 cm
18001 • Chemin de table 50 x 270 cm
18000 • Serviette de table 60 x 60 cm



BIARRITZ

35994 • Nappe 270 x 270 cm
35993 • Nappe 220 x 350 cm



DAVOS

30029 • Nappe 210 x 210 cm
30031 • Nappe 270 x 270 cm
30032 • Nappe 270 x 400 cm
30033 • Nappe 270 x 600 cm
30034 • Serviette de table 50 x 50 cm

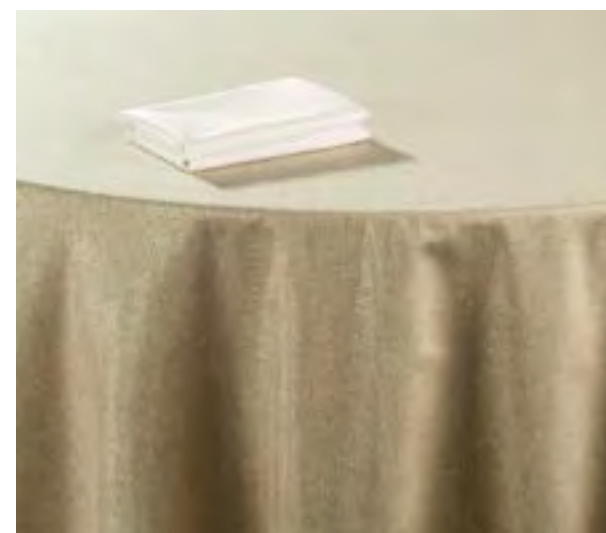

DUBAÏ DORÉ

13284 • Nappe 210 x 210 cm
13285 • Nappe 300 x 300 cm
13286 • Nappe 300 x 400 cm
13287 • Nappe 300 x 500 cm
13288 • Nappe 300 x 600 cm
13761 • Chemin de table 50 x 270 cm

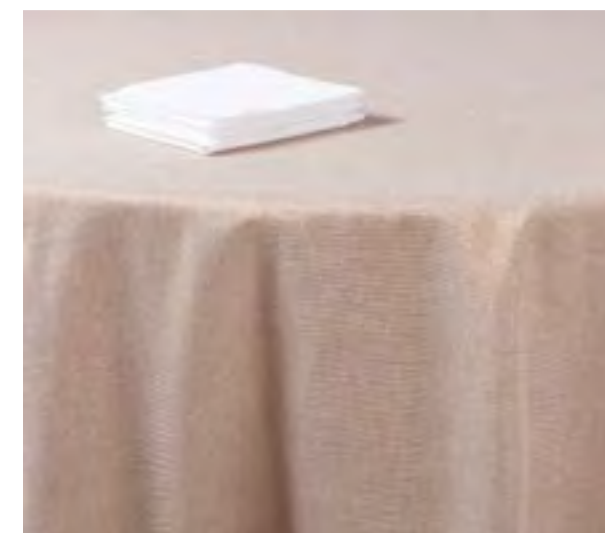

DUBAÏ CUIVRÉ

30035 • Nappe 210 x 210 cm
30036 • Nappe 300 x 300 cm
30037 • Nappe 300 x 400 cm
30038 • Nappe 300 x 600 cm
30039 • Chemin de table 50 x 270 cm



NAPPES ET SERVIETTES

GAMME EXCLUSIVE
★★★★☆



TOSCANE BLEU NUIT

- 23105 • Nappe 210 x 210 cm
- 23106 • Nappe 280 x 280 cm
- 23107 • Nappe 280 x 400 cm
- 23108 • Nappe 280 x 500 cm
- 23109 • Nappe 280 x 600 cm
- 23110 • Nappe 280 x 800 cm
- 23103 • Chemin de table 50 x 270 cm
- 23111 • Serviette de table 60 x 60 cm

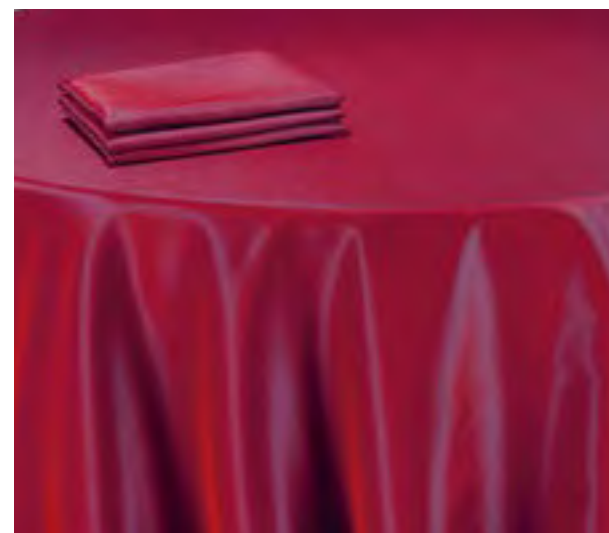

TOSCANE GRENADE

- 20567 • Nappe 210 x 210 cm
- 20568 • Nappe 280 x 280 cm
- 20569 • Nappe 280 x 400 cm
- 20570 • Nappe 280 x 500 cm
- 20571 • Nappe 280 x 600 cm
- 20572 • Nappe 280 x 800 cm
- 20564 • Chemin de table 50 x 270 cm
- 20565 • Serviette de table 60 x 60 cm

GAMME EXCLUSIVE
★★★★☆



TOSCANE CHOCOLAT

- 11532 • Nappe 210 x 210 cm
- 11388 • Nappe 280 x 280 cm
- 11389 • Nappe 280 x 400 cm
- 11390 • Nappe 280 x 500 cm
- 11391 • Nappe 280 x 600 cm
- 11673 • Nappe 280 x 800 cm
- 11534 • Chemin de table 50 x 270 cm
- 11392 • Serviette de table 60 x 60 cm



TOSCANE CASSIS

- 19038 • Nappe 210 x 210 cm
- 19039 • Nappe 280 x 280 cm
- 19040 • Nappe 280 x 400 cm
- 19041 • Nappe 280 x 500 cm
- 19043 • Nappe 280 x 600 cm
- 19046 • Nappe 280 x 800 cm
- 19035 • Chemin de table 50 x 270 cm
- 19036 • Serviette de table 60 x 60 cm

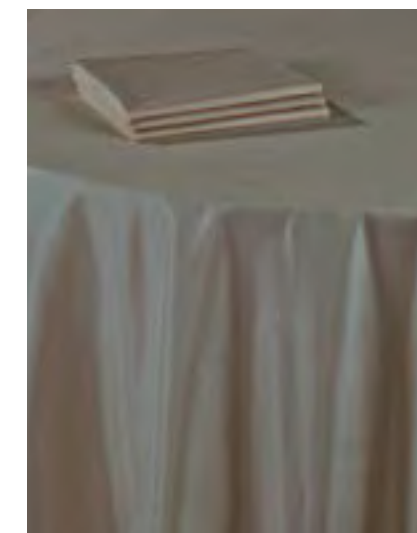

TOSCANE TAUPE

- 16300 • Nappe 210 x 210 cm
- 16305 • Nappe 280 x 280 cm
- 16301 • Nappe 280 x 400 cm
- 16302 • Nappe 280 x 500 cm
- 16303 • Nappe 280 x 600 cm
- 16304 • Nappe 280 x 800 cm
- 16306 • Chemin de table 50 x 270 cm
- 16307 • Serviette de table 60 x 60 cm



TOSCANE BRONZE

- 17922 • Nappe 210 x 210 cm
- 17923 • Nappe 280 x 280 cm
- 17924 • Nappe 280 x 400 cm
- 17925 • Nappe 280 x 500 cm
- 17926 • Nappe 280 x 600 cm
- 17927 • Nappe 280 x 800 cm
- 17921 • Chemin de table 50 x 270 cm
- 17920 • Serviette de table 60 x 60 cm

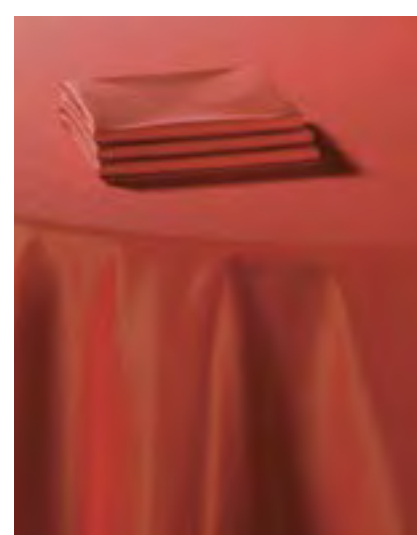

TOSCANE MANDARINE

- 12911 • Nappe 210 x 210 cm
- 12912 • Nappe 280 x 280 cm
- 12913 • Nappe 280 x 400 cm
- 12914 • Nappe 280 x 500 cm
- 12915 • Nappe 280 x 600 cm
- 12916 • Nappe 280 x 800 cm
- 12909 • Chemin de table 50 x 270 cm
- 12917 • Serviette de table 60 x 60 cm



TOSCANE ACIER

- 11832 • Nappe 210 x 210 cm
- 11833 • Nappe 280 x 280 cm
- 11834 • Nappe 280 x 400 cm
- 11835 • Nappe 280 x 500 cm
- 11836 • Nappe 280 x 600 cm
- 11837 • Nappe 280 x 800 cm
- 11830 • Chemin de table 50 x 270 cm
- 11838 • Serviette de table 60 x 60 cm

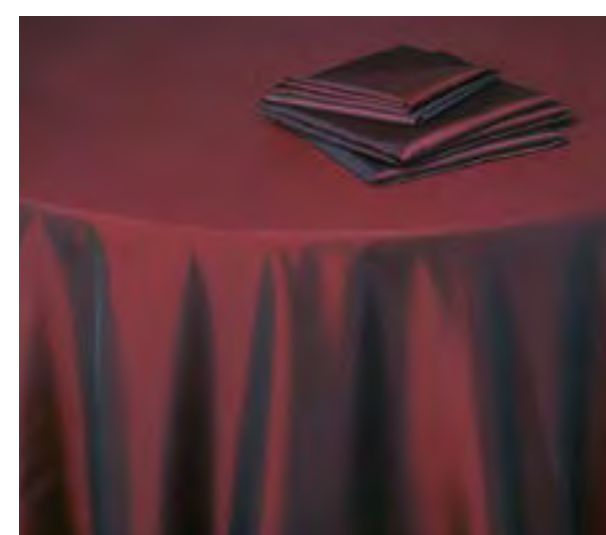

TOSCANE ROUGE OPÉRA

- 11533 • Nappe 210 x 210 cm
- 11393 • Nappe 280 x 280 cm
- 11394 • Nappe 280 x 400 cm
- 11395 • Nappe 280 x 500 cm
- 11396 • Nappe 280 x 600 cm
- 11674 • Nappe 280 x 800 cm
- 11535 • Chemin de table 50 x 270 cm
- 11397 • Serviette de table 60 x 60 cm

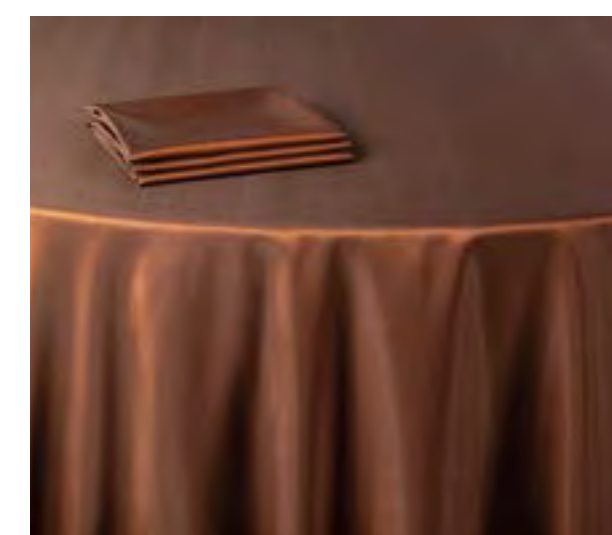

TOSCANE CUIVRE

- 20843 • Nappe 210 x 210 cm
- 20844 • Nappe 280 x 280 cm
- 20845 • Nappe 280 x 400 cm
- 20846 • Nappe 280 x 500 cm
- 20847 • Nappe 280 x 600 cm
- 20848 • Nappe 280 x 800 cm
- 20849 • Chemin de table 50 x 270 cm
- 20850 • Serviette de table 60 x 60 cm



NAPPES ET SERVIETTES

GAMME EXCLUSIVE
★★★★☆

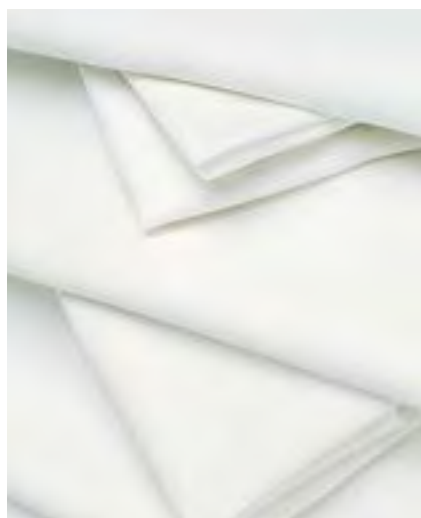

LIN BLANC

- 4262 • Nappe 180 x 180 cm
- 4265 • Nappe 210 x 350 cm
- 35939 • Nappe 220 x 320 cm
- 35941 • Nappe 220 x 800 cm
- 4263 • Nappe 240 x 240 cm
- 4264 • Nappe 270 x 270 cm
- 4266 • Nappe 270 x 500 cm
- 4267 • Nappe 270 x 600 cm
- 4268 • Nappe 270 x 900 cm
- 4269 • Nappe 270 x 1200 cm
- 11232 • Chemin de table 50 x 270 cm
- 4261 • Serviette de table 50 x 50 cm



LIN BLEU

- 29604 • Nappe 220 x 350 cm
- 30603 • Nappe 220 x 500 cm
- 30604 • Nappe 220 x 600 cm
- 24251 • Nappe 290 x 290 cm
- 24250 • Chemin de table 50 x 390 cm
- 24252 • Serviette de table 50 x 50 cm

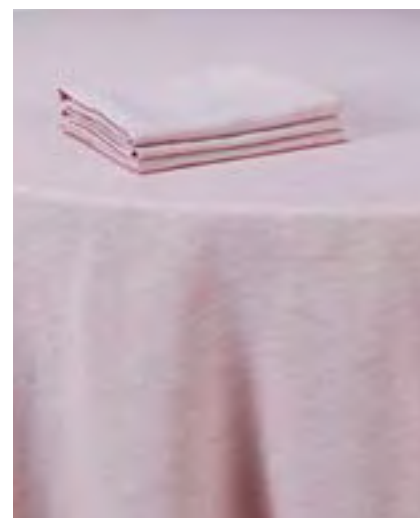

LIN ROSE

- 19303 • Nappe 210 x 210 cm
- 19304 • Nappe 290 x 290 cm
- 19305 • Nappe 290 x 400 cm
- 19306 • Nappe 290 x 500 cm
- 19307 • Nappe 290 x 600 cm
- 19308 • Nappe 290 x 800 cm
- 19309 • Chemin de table 50 x 270 cm
- 19310 • Serviette de table 60 x 60 cm



LIN CHAUME

- 10892 • Nappe 210 x 210 cm
- 9770 • Nappe 240 x 240 cm
- 9771 • Nappe 290 x 290 cm
- 9772 • Nappe 290 x 400 cm
- 9773 • Nappe 290 x 500 cm
- 9774 • Nappe 290 x 600 cm
- 9775 • Nappe 290 x 800 cm
- 11639 • Chemin de table 50 x 270 cm
- 9776 • Serviette de table 60 x 60 cm

GAMME EXCLUSIVE
★★★★☆

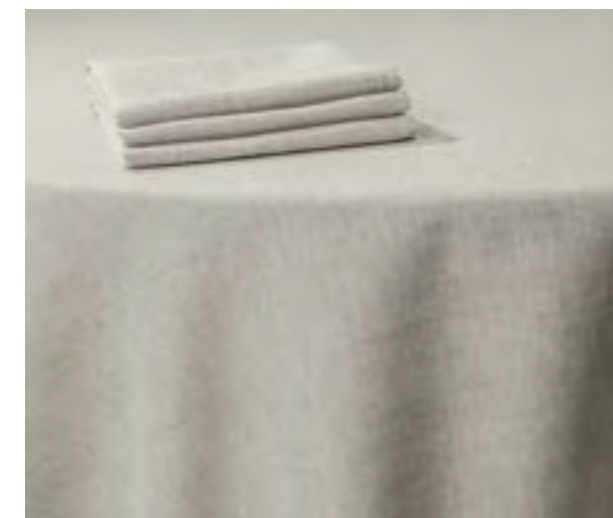

LIN FICELLE

- 26960 • Nappe 210 x 210 cm
- 29609 • Nappe 220 x 350 cm
- 26961 • Nappe 290 x 290 cm
- 26950 • Nappe 290 x 400 cm
- 26949 • Nappe 290 x 500 cm
- 26962 • Nappe 290 x 600 cm
- 26880 • Chemin de table 50 x 270 cm
- 27025 • Serviette de table 50 x 50 cm

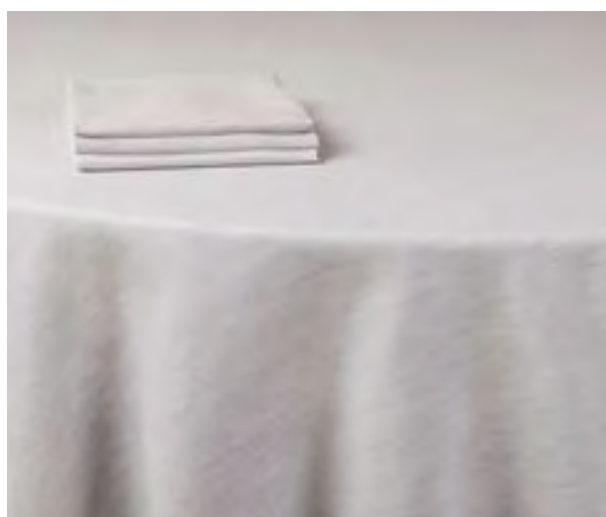

LIN GRIS

- 19294 • Nappe 210 x 210 cm
- 19295 • Nappe 290 x 290 cm
- 19296 • Nappe 290 x 400 cm
- 19297 • Nappe 290 x 500 cm
- 19298 • Nappe 290 x 600 cm
- 19299 • Nappe 290 x 800 cm
- 19300 • Chemin de table 50 x 270 cm
- 19301 • Serviette de table 60 x 60 cm

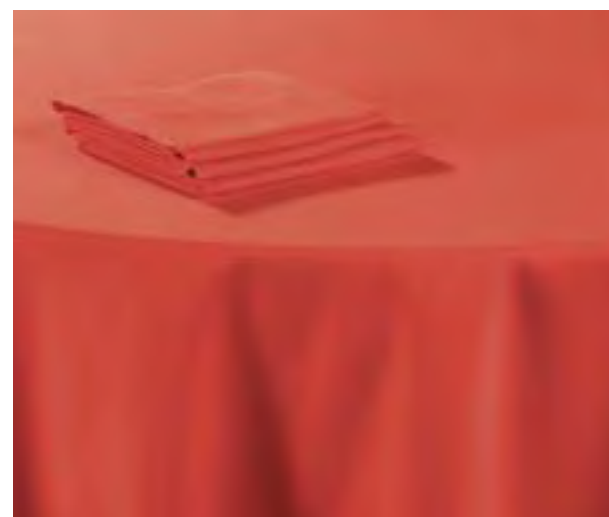

LIN CORAIL

- 11814 • Nappe 210 x 210 cm
- 11815 • Nappe 290 x 290 cm
- 11816 • Nappe 290 x 400 cm
- 11817 • Nappe 290 x 500 cm
- 11818 • Nappe 290 x 600 cm
- 11819 • Nappe 290 x 800 cm
- 11812 • Chemin de table 50 x 270 cm
- 11820 • Serviette de table 60 x 60 cm



LIN ROUGE

- 26963 • Nappe 210 x 210 cm
- 26964 • Nappe 290 x 290 cm
- 26952 • Nappe 290 x 400 cm
- 26951 • Nappe 290 x 500 cm
- 26965 • Nappe 290 x 600 cm
- 26881 • Chemin de table 50 x 270 cm
- 27026 • Serviette de table 50 x 50 cm



LIN VERT

- 30900 • Nappe 210 x 210 cm
- 30499 • Nappe 290 x 290 cm
- 30498 • Nappe 290 x 400 cm
- 30903 • Nappe 290 x 600 cm
- 34900 • Chemin de table 50 x 270 cm
- 24605 • Serviette de table 50 x 50 cm



NAPPES ET SERVIETTES

GAMME EXCLUSIVE
★★★★☆

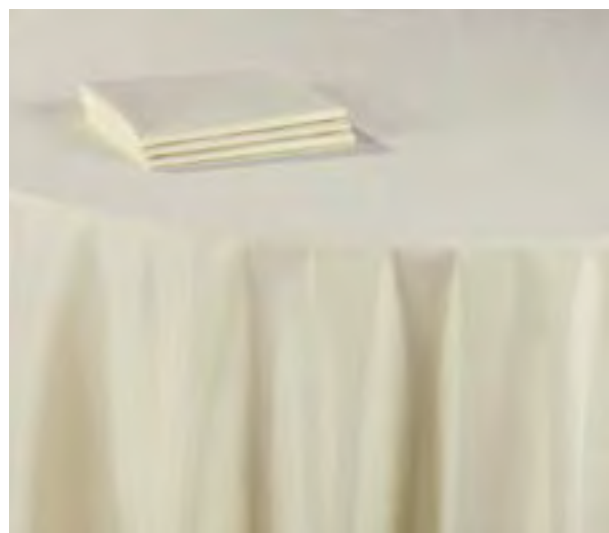

DELHI CHAMPAGNE •  
14050 • Nappe 210 x 210 cm
14052 • Nappe 300 x 400 cm
14053 • Nappe 300 x 500 cm
14054 • Nappe 300 x 600 cm
14596 • Nappe 300 x 800 cm
14051 • Nappe 310 x 310 cm
14058 • Chemin de table 50 x 270 cm
14057 • Serviette de table 60 x 60 cm

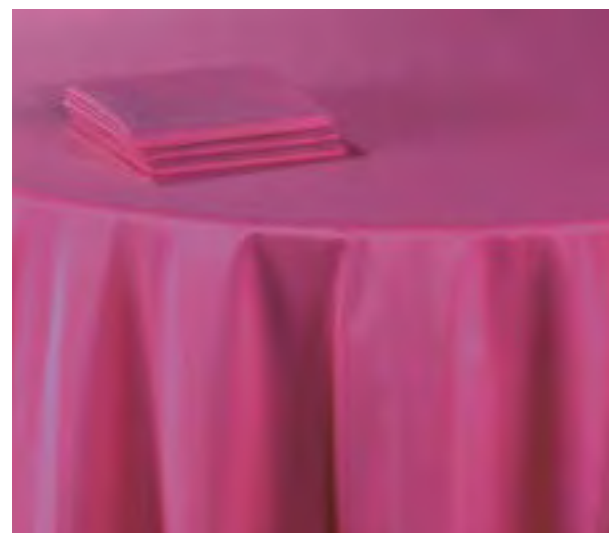

DELHI FUCHSIA •  
15146 • Nappe 210 x 210 cm
15148 • Nappe 300 x 400 cm
15149 • Nappe 300 x 500 cm
15150 • Nappe 300 x 600 cm
15261 • Nappe 300 x 800 cm
15147 • Nappe 310 x 310 cm
15151 • Chemin de table 50 x 270 cm
15152 • Serviette de table 60 x 60 cm





TOILE DE JOUY BRIQUE 
35323 • Nappe 200 x 300 cm
26729 • Nappe 270 x 270 cm
35317 • Serviette de table 50 x 50 cm



TOILE DE JOUY BLEU 
35322 • Nappe 200 x 300 cm
26726 • Nappe 270 x 270 cm
35316 • Serviette de table 50 x 50 cm

GAMME EXCELLENCE
★★★★★



DELHI PRUNE •  
14040 • Nappe 210 x 210 cm
14042 • Nappe 300 x 400 cm
14043 • Nappe 300 x 500 cm
14044 • Nappe 300 x 600 cm
14597 • Nappe 300 x 800 cm
14041 • Nappe 310 x 310 cm
14059 • Chemin de table 50 x 270 cm
14055 • Serviette de table 60 x 60 cm



DELHI VERT CÉLADON •  
14045 • Nappe 210 x 210 cm
14047 • Nappe 300 x 400 cm
14048 • Nappe 300 x 500 cm
14049 • Nappe 300 x 600 cm
14617 • Nappe 300 x 800 cm
14046 • Nappe 310 x 310 cm
14060 • Chemin de table 50 x 270 cm
14056 • Serviette de table 60 x 60 cm



TOILE DE JOUY VERT 
35318 • Nappe 200 x 300 cm
35321 • Nappe 270 x 270 cm
35315 • Serviette de table 50 x 50 cm



NAPPE IMPRIMÉE SUR-MESURE
i Les évolutions techniques permettent aujourd'hui de créer votre nappage et de pouvoir le réaliser spécifiquement pour votre réception.
N'hésitez pas à l'imaginer ou le faire imaginer par nos scénographes qui vous élaboreront plusieurs propositions.
Couleur de base : blanche
Couleurs imprimables : toutes les couleurs
Délai de réalisation : sur consultation
Formes de nappe : ronde, rectangulaire, ovale, carrée



GAZES DE COTON, MOLLETONS ET FEUTRINES

GAZE DE COTON



34711
ML Gaze de coton
blanc larg 130 cm • *



34709
ML Gaze de coton
brique larg 130 cm • *

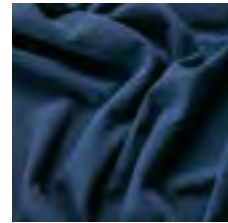

34707
ML Gaze de coton
bleu larg 130 cm • *



34708
ML Gaze de coton
rouge larg 130 cm • *



34710
ML Gaze de coton
vert larg 130 cm • *



35851
ML gaze de coton
beige larg 130 cm • *



35850
ML gaze de coton
rose poudré larg 130 cm • *

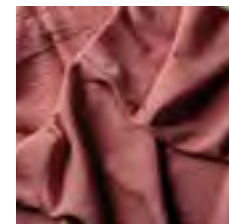

35849
ML gaze de coton
vieux rose larg 130 cm • *



35848
ML gaze de coton
turquoise larg 130 cm • *

i La gaze de coton est un tissu fin et léger, d'aspect gaufré.
Vous pourrez l'utiliser comme chemin de table, sur des buffets ou encore pour habiller le dossier des chaises.
Un accessoire déco indispensable !



29965
Sets de table / serviettes
tissu vert d'eau 32 x 48 cm
en rouleau par 12 • *

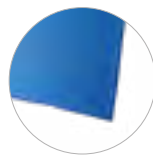

25970
Bleu • *

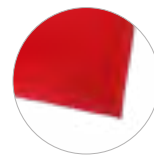

25860
Rouge • *



25865
Brique • *

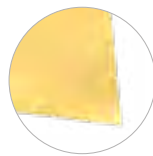

29962
Jaune moutarde • *



25858
Ecru • *



25859
Noir • *



18686
Rouleau de 12 serviettes
21 x 21 cm
tissu vichy rouge • *



22897
Chemin de table en toile de jute
30 cm x 5 m • *



18680
Set de table tissu chocolat
32 x 48 cm (par 30) • *



13833
Set de table Cazak fumé
31 x 40 cm



11494
Set de table Club
36 x 49 cm

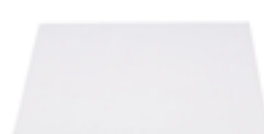

27183
Set de table Alaska
coton blanc 30 x 45 cm



26183
Serviette de table
Jour Venise 45 x 45 cm



20733
Serviettes cocktail tissu anthracite
20 x 20 cm (par 30) • *



25971
Serviettes cocktail tissu bleu
20 x 20 cm (par 30) • *



18682
Serviettes cocktail tissu chocolat
20 x 20 cm (par 30) • *



10822
Serviettes cocktail tissu écru
20 x 20 cm (par 30) • *



18360
Serviettes cocktail tissu fuchsia
20 x 20 cm (par 30) • *



10821
Serviettes cocktail tissu noir
20 x 20 cm (par 30) • *



13201
Serviettes cocktail tissu rouge
20 x 20 cm (par 30) • *



20734
Serviettes cocktail tissu ficelle
20 x 20 cm (par 30) • *



25674
Distributeur de serviettes bambou
12 x 12 cm H 10 cm



24446
Pochette à couverts • *

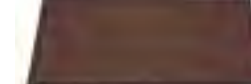

18685
Serviettes tissu chocolat 2 plis
16 x 24 cm (par 10) • *

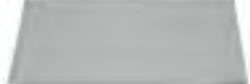

18684
Serviettes tissu céladon 2 plis
16 x 24 cm (par 10) • *

MOLLETON COTON

- | | | |
|-----------------------------------|-----------------------------------|-------------------------------------|
| 083 • Molleton coton 130 x 130 cm | 082 • Molleton coton 130 x 600 cm | 10816 • Molleton coton 220 x 300 cm |
| 422 • Molleton coton 130 x 220 cm | 079 • Molleton coton 130 x 700 cm | 11221 • Molleton coton 220 x 400 cm |
| 075 • Molleton coton 130 x 240 cm | 330 • Molleton coton 130 x 800 cm | 10817 • Molleton coton 220 x 500 cm |
| 423 • Molleton coton 130 x 270 cm | 080 • Molleton coton 130 x 900 cm | 11222 • Molleton coton 220 x 600 cm |
| 076 • Molleton coton 130 x 300 cm | 074 • Molleton coton 170 x 170 cm | 10818 • Molleton coton 220 x 700 cm |
| 077 • Molleton coton 130 x 400 cm | 084 • Molleton coton 180 x 180 cm | |
| 078 • Molleton coton 130 x 500 cm | 085 • Molleton coton 210 x 210 cm | |

MOLLETON SYNTHÉTIQUE

- 460 • Mètre linéaire de molleton synthétique largeur 150 cm • *

FEUTRINES • *

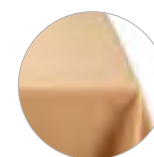

4213
Feutrine beige
180 x 180 cm
11647
Feutrine beige
180 x 300 cm
4214
Feutrine beige
180 x 360 cm

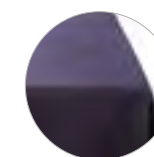

4207
Feutrine bleu marine
180 x 180 cm
11648
Feutrine bleu marine
180 x 300 cm
4208
Feutrine bleu marine
180 x 360 cm



4210
Feutrine bleu roi
180 x 180 cm
11649
Feutrine bleu roi
180 x 300 cm
4211
Feutrine bleu roi
180 x 360 cm

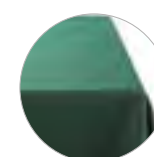

4201
Feutrine verte
180 x 180 cm
11653
Feutrine verte
180 x 300 cm
4202
Feutrine verte
180 x 360 cm

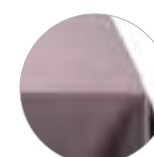

4204
Feutrine grise
180 x 180 cm
11651
Feutrine grise
180 x 300 cm
4205
Feutrine grise
180 x 360 cm



4216
Feutrine rouge
180 x 180 cm
11652
Feutrine rouge
180 x 300 cm
4217
Feutrine rouge
180 x 360 cm



4219
Feutrine bordeaux
180 x 180 cm
11650
Feutrine bordeaux
180 x 300 cm
4220
Feutrine bordeaux
180 x 360 cm

TEXTILES ET TOILES CIRÉES

MONSÉGUR (MÈTRE LINÉAIRE) •

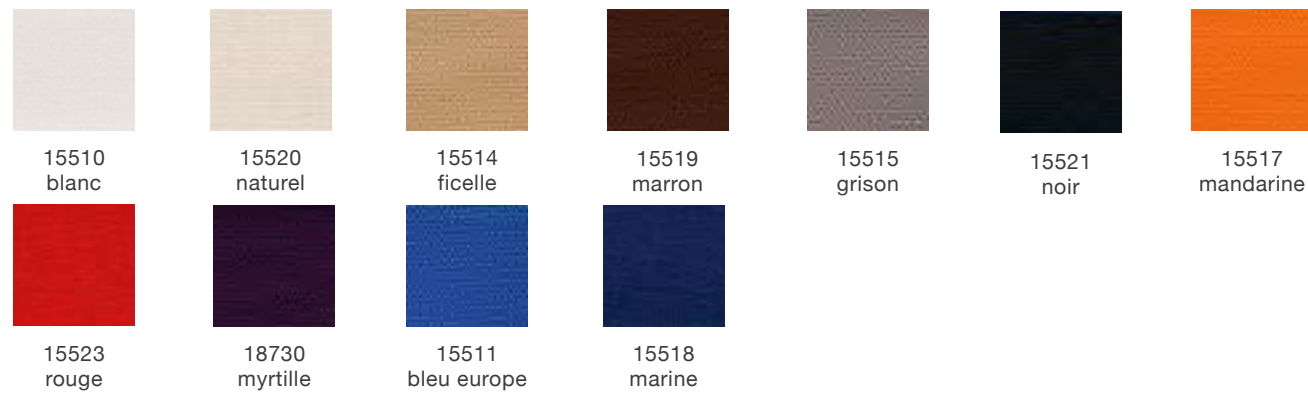

COTON GRATTÉ (MÈTRE LINÉAIRE)

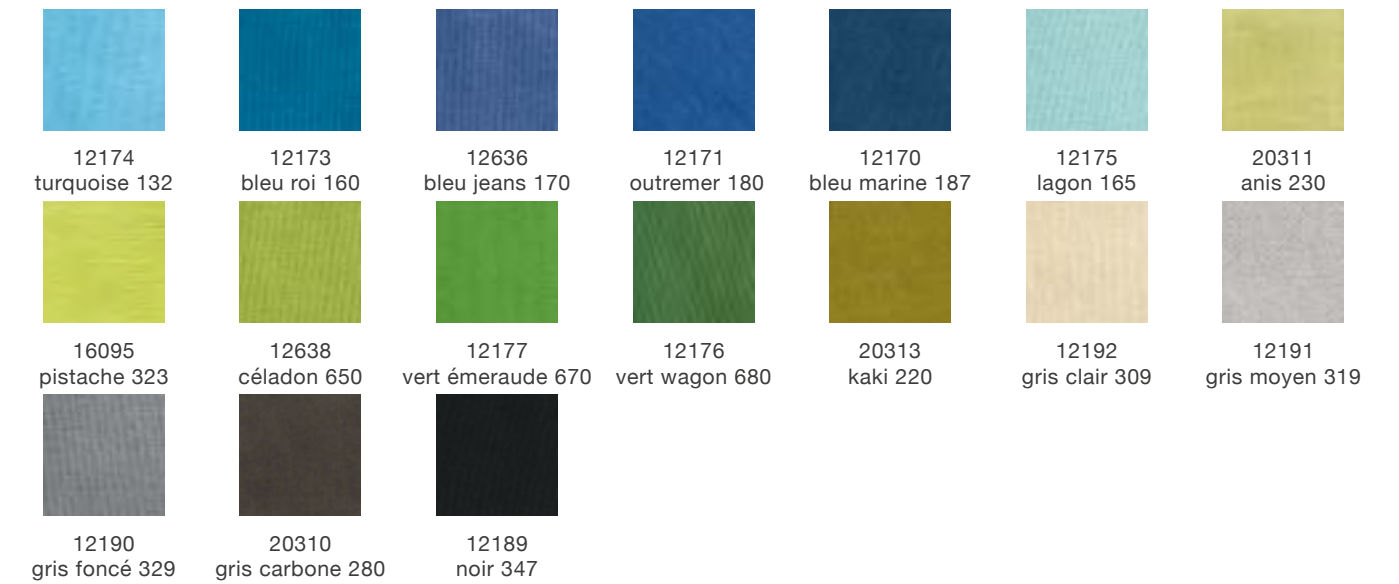

COTON GRATTÉ (MÈTRE LINÉAIRE)

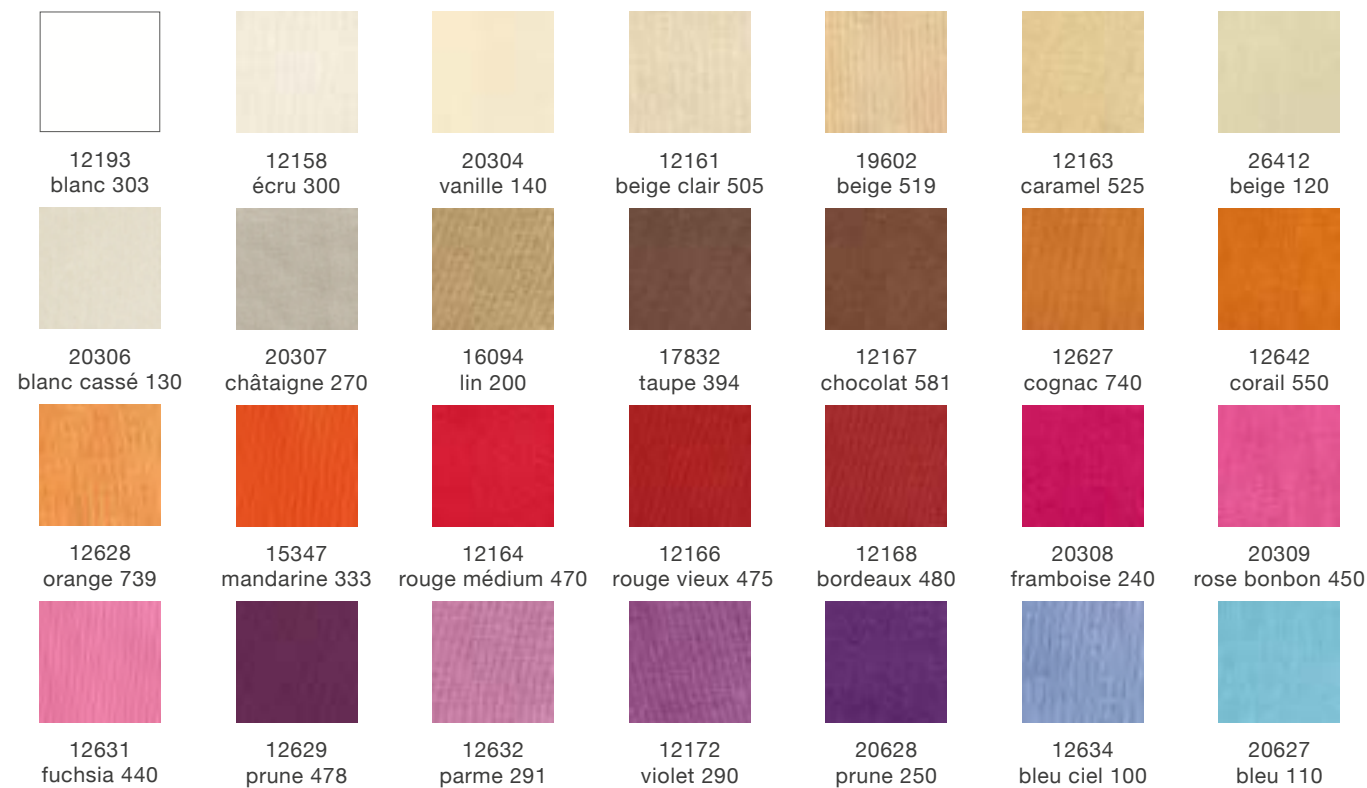



TOILE CIRÉE (MÈTRE LINÉAIRE) •





ASSIETTES

Lignes d'assiettes.....	152
Les uniques	190
Dessous d'assiettes et assiettes de présentation.....	190
Petites assiettes cocktail.....	193

 : Origine France  : Origine Union Européenne

LIGNES D'ASSIETTES

GAMME STANDARD



Harmony
page 154

Rohan
page 154

Bruges
page 155

Luberon
page 155

GAMME ÉLÉGANCE



Dune
page 158

Lak
page 158

Plane filet argent
page 159

Plane filet or
page 159

Oslo
page 159

Romance
page 162

Frisson
page 162

Perle nacrée
page 162

Marbre
page 163

Dentelle
page 163

Onyx
page 166

Couleur
page 166

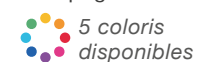

GAMME EXCLUSIVE



Sahara
page 167

Andalouse
page 167

Raphaël
page 167

Végétale
page 170

Volcan doré
page 170

Lagon
page 170

Azul
page 171

Corfou
page 171

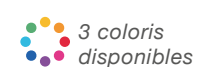

Karo
page 172

Luxor
page 172

"C"
page 173

Platinum
page 173

GAMME EXCELLENCE



Hémisphère
page 176

Versace
page 176

Plumes
page 177

Marbre filet or
page 177

Porto Alegre
page 182

Gien bleue
page 182

Météor
page 183

Broadway
page 183

Goldring
page 183

Capri
page 186

Olivier
page 186

Fantasia
page 186

VAISSELLE VINTAGE

Vintage blanche et dorée
page 187

Vintage bleu vert
page 187

Vintage fleurie
page 187

LES UNIQUES

RETROUVEZ LES DESSOUS D'ASSIETTES ET LES ASSIETTES DE PRÉSENTATION page 190

RETROUVEZ LES PETITES ASSIETTES COCKTAIL page 193

LIGNES D'ASSIETTES

GAMME STANDARD ★☆☆☆

HARMONY



24618
Assiette de présentation Ø 30,5 cm
24673
Assiette plate Ø 26,5 cm
24678
Assiette lunch Ø 20 cm



24674
Assiette creuse Ø 19 cm



24774
Assiette à pain Ø 16,5 cm



24730
Tasse et sous-tasse à café 11 cl



24777
Tasse et sous-tasse à thé 20 cl

ROHAN



2413
Assiette de présentation Ø 28 cm
663
Assiette plate Ø 26 cm
248
Assiette lunch Ø 21 cm



659
Assiette creuse
Ø 23 cm bassin 15 cm



2414
Assiette à pain Ø 16,5 cm



2350
Tasse et sous-tasse à café 13 cl



2351
Tasse et sous-tasse à thé 23 cl



2417
Tasse et sous-tasse à déjeuner 44 cl

BRUGES



19124
Assiette de présentation Ø 31 cm
19125
Assiette plate Ø 27 cm
19126
Assiette lunch Ø 20 cm



19127
Assiette creuse
Ø 27 cm bassin 14 cm



19128
Assiette à pain Ø 13 cm



19227
Tasse et sous-tasse à café 9 cl



19230
Tasse et sous-tasse à thé 22 cl

LUBERON



19114
Assiette plate Ø 28 cm
19115
Assiette lunch Ø 22 cm



19116
Assiette creuse
Ø 26 cm bassin 14 cm



19122
Tasse et sous-tasse à café 9 cl



19123
Tasse et sous-tasse à thé 26 cl

GAMME STANDARD ★☆☆☆

GAMME ÉLÉGANCE ★★☆☆



LIGNES D'ASSIETTES

GAMME ÉLÉGANCE ★★☆☆

DUNE  



9742
Assiette de présentation Ø 31 cm
9743
Assiette plate Ø 27 cm
10149
Assiette lunch Ø 21,5 cm



9744
Assiette creuse à aile
Ø 22 cm bassin 13,5 cm



9745
Assiette à pain
Lak Dune Ø 15 cm



16132
Assiette coupe
Lak Dune Ø 29 cm

LAK 



12890
Assiette de présentation Ø 31 cm
15542
Assiette plate Ø 27 cm
15543
Assiette lunch Ø 21,5 cm



9746
Bol Lak Dune Ø 18 cm



9748
Tasse et sous-tasse à café
Lak Dune 9 cl



9749
Tasse et sous-tasse à thé
Lak Dune 16 cl



9747
Bol à consommé Lak Dune
Ø 11 cm H 5,5 cm 20 cl
9753
Sous-tasse à thé Lak Dune



24241
Tasse et sous-tasse à déjeuner
Lak Dune 40 cl

PLANE FILET ARGENT



26714
Assiette de présentation Ø 29 cm
26716
Assiette plate Ø 27 cm
26718
Assiette lunch Ø 23 cm

PLANE FILET OR



26713
Assiette de présentation Ø 29 cm
26715
Assiette plate Ø 27 cm
26717
Assiette lunch Ø 23 cm

OSLO



35544
Assiette de présentation Ø 32 cm
35543
Assiette plate Ø 27 cm
35542
Assiette lunch Ø 21 cm

GAMME ÉLÉGANCE ★★☆☆



28342
Assiette creuse
Ø 27 cm bassin 15 cm



27764
Tasse et sous-tasse à café 12 cl



28341
Assiette creuse
Ø 27 cm bassin 15 cm



27761
Tasse et sous-tasse à café 12 cl



29855
Assiette à pain Ø 12 cm



27770
Tasse et sous-tasse à thé 22 cl



29854
Assiette à pain Ø 12 cm



27768
Tasse et sous-tasse à thé 22 cl



35541
Assiette à pain Ø 14 cm



LIGNES D'ASSIETTES

ROMANCE



21360
Assiette plate Ø 30 cm
21361
Assiette lunch Ø 23 cm

GAMME ÉLÉGANCE ★★☆☆



21362
Assiette creuse
Ø 24 cm bassin 12,5 cm



29966
Tasse et sous-tasse à café 9 cl



21363
Assiette à pain Ø 17 cm



29967
Tasse et sous-tasse à thé 20 cl

FRISSON



35829
Assiette plate Ø 28 cm



35828
Assiette creuse Ø 16 cm

PERLE NACRÉE



35612
Assiette de présentation Ø 33 cm
35613
Assiette plate Ø 28 cm
35614
Assiette lunch Ø 22 cm



35615
Assiette à pain Ø 17 cm

MARBRE



29838
Assiette de présentation Ø 30 cm
29839
Assiette plate Ø 27 cm
29840
Assiette lunch Ø 22 cm

GAMME ÉLÉGANCE ★★☆☆



29841
Assiette creuse Ø 21,5 cm



29969
Tasse et sous-tasse à café 14 cl



29970
Tasse et sous-tasse à thé 25 cl

DENTELLE



34547
Assiette de présentation
bleu pastel Ø 33 cm



34551
Assiette de présentation
crème Ø 33 cm



34555
Assiette creuse
bleu pastel Ø 23 cm



34553
Assiette plate
crème Ø 28 cm



34548
Assiette lunch
bleu pastel Ø 23 cm



34550
Assiette à pain
crème Ø 15 cm



34546
Assiette à pain
bleu pastel Ø 15 cm



LIGNES D'ASSIETTES

GAMME ÉLÉGANCE ★★☆☆

ONYX



26517 Assiette de présentation Ø 30 cm
26516 Assiette plate Ø 27,5 cm
26515 Assiette lunch Ø 25 cm



26518 Assiette creuse Ø 23 cm bassin 10 cm



26848 Assiette à pain Ø 14,5 cm



20069 Tasse à café Carbone 8 cl



20068 Tasse à thé Carbone 20 cl

COULEUR



BANQUISE
27731 Assiette de présentation Ø 31 cm
27726 Assiette plate Ø 26 cm
27721 Assiette lunch Ø 20 cm



GUIMAUVE
27732 Assiette de présentation Ø 31 cm
27727 Assiette plate Ø 26 cm
27722 Assiette lunch Ø 20 cm



CÉLADON
27730 Assiette de présentation Ø 31 cm
27725 Assiette plate Ø 26 cm
27720 Assiette lunch Ø 20 cm



PÊCHE
27733 Assiette de présentation Ø 31 cm
27728 Assiette plate Ø 26 cm
27723 Assiette lunch Ø 20 cm



ARDOISE
27729 Assiette de présentation Ø 31 cm
27724 Assiette plate Ø 26 cm
27719 Assiette lunch Ø 20 cm

SAHARA



30856 Assiette plate Ø 26 cm
30857 Assiette lunch Ø 22 cm

GAMME EXCLUSIVE ★★★★



30858 Assiette à pain Ø 13 cm



30863 Tasse et sous-tasse à café 9 cl



30859 Assiette creuse Ø 21 cm



30866 Tasse et sous-tasse à thé 18 cl

ANDALOUSE



29860 Assiette plate Ø 27 cm



29861 Assiette lunch Ø 21 cm (dépareillée)

RAPHAËL



35595 Assiette de présentation Ø 33 cm



35594 Assiette à pain Ø 15 cm



LIGNES D'ASSIETTES

GAMME EXCLUSIVE
★★★★☆

VÉGÉTALE



35616
Assiette de présentation Ø 31 cm
35617
Assiette lunch Ø 22 cm



35618
Assiette à pain Ø 17 cm

VOLCAN DORÉ



35598
Assiette plate Ø 27,5 cm
35597
Assiette lunch Ø 22 cm



35596
Assiette à pain Ø 18 cm

LAGON



29459
Assiette plate Ø 27 cm
29460
Assiette lunch Ø 21 cm



29461
Assiette à pain Ø 10 cm



30889
Assiette creuse
Ø 25,5 cm H 4,6 cm

AZUL



25465
Assiette de présentation Ø 32 cm



25480
Assiette lunch Ø 22,5 cm



25482
Assiette plate Ø 27,5 cm



25477
Assiette creuse Ø 22 cm



Suggestion de présentation

CORFOU



26720
Assiette plate rouge
Ø 26 cm



28390
Assiette à pain rouge
Ø 16,5 cm



26719
Assiette plate beige
Ø 26 cm



28389
Assiette à pain beige
Ø 16,5 cm



26850
Assiette plate bleue
Ø 27 cm



28388
Assiette à pain bleue
Ø 16,5 cm

 Bols Corfou assortis page 251

LIGNES D'ASSIETTES

GAMME EXCLUSIVE
★★★★☆

KARO



11569
Assiette de présentation 31 x 31 cm
11570
Assiette plate 26 x 26 cm
11571
Assiette lunch 21 x 21 cm



11725
Assiette à pain
11,5 x 11,5 cm

LUXOR



19231
Assiette de présentation Ø 33 cm
19232
Assiette plate Ø 28 cm
19233
Assiette lunch Ø 25 cm



19235
Assiette coupe Ø 29 cm



19236
Assiette creuse à aile
Ø 29 cm bassin 14 cm



19234
Assiette à pain Ø 16 cm



19240
Tasse et sous-tasse à café 8 cl



19241
Tasse et sous-tasse à thé 25 cl

GAMME EXCLUSIVE
★★★★☆

" C " • VILLEROY & BOCH - CRÉATION DE COORRENGEL & CALVAGRAC



16166
Assiette de présentation Ø 32 cm
16167
Assiette plate platine Ø 27 cm
16168
Assiette lunch Ø 21,5 cm



17985
Assiette plate or Ø 27 cm
16195
Assiette à pain Ø 16 cm



16169
Assiette creuse Ø 28 cm



16167
Assiette plate platine Ø 27 cm



16175
Tasse et sous-tasse à café 8 cl



16176
Tasse et sous-tasse à thé 20 cl

PLATINIUM



19210
Assiette de présentation Ø 33 cm
19211
Assiette plate Ø 28 cm
19212
Assiette lunch Ø 22 cm



19214
Assiette creuse
Ø 24 cm bassin 15,5 cm



19213
Assiette à pain Ø 16 cm



19219
Tasse et sous-tasse à café 10 cl



19220
Tasse et sous-tasse à thé 20 cl



LIGNES D'ASSIETTES

GAMME EXCELLENCE
★★★★

HÉMISPÈRE • J.L COQUET  COLLECTION*



17817
Assiette de présentation Ø 32 cm
17819
Assiette plate Ø 27 cm
17818
Assiette lunch Ø 21 cm



17816
Assiette creuse
Ø 26 cm bassin 12 cm



17815
Assiette à pain Ø 15,5 cm

VERSACE  COLLECTION*



22690
Assiette de présentation Ø 33 cm



22692
Assiette plate Ø 28 cm
22693
Assiette lunch Ø 22 cm



22689
Assiette à pain Ø 10 cm



22691
Assiette creuse Ø 24 cm



22698
Tasse et sous-tasse
à café 10 cl



22699
Tasse et sous-tasse
à thé 25 cl

* Produits extraits de l'offre Options Collection. Retrouvez plus de produits sur www.options.net en recherchant « Options collection » ou demandez le catalogue Options Collection.

GAMME EXCELLENCE
★★★★

PLUMES  *Marie Jaëge* PARIS COLLECTION*



29555
Assiette de présentation Ø 30 cm



29556
Assiette à pain Ø 13 cm



29561
Tasse et sous-tasse à café 12 cl



29562
Tasse et sous-tasse à thé 20 cl

MARBRE FILET OR  COLLECTION*



29565
Assiette de présentation Ø 33 cm
29566
Assiette plate Ø 28 cm
29567
Assiette lunch Ø 22 cm



29568
Assiette à pain Ø 16 cm

* Produits extraits de l'offre Options Collection. Retrouvez plus de produits sur www.options.net en recherchant « Options collection » ou demandez le catalogue Options Collection.





LIGNES D'ASSIETTES

GAMME EXCELLENCE
★★★★

PORTO ALEGRE  COLLECTION *



29857
Assiette de présentation Ø 33 cm



29859
Assiette plate Ø 28 cm
29858
Assiette lunch Ø 20 cm



29856
Assiette à pain Ø 16 cm

GIEN BLEUE  COLLECTION *



32905
Assiette plate Ø 27,5 cm



32904
Assiette lunch Ø 23 cm



32902
Assiette à pain Ø 13 cm



32903
Assiette creuse Ø 23 cm



32900
Tasse et sous-tasse à café 8,5 cl



32901
Tasse et sous-tasse à thé 17,5 cl

MÉTÉOR  COLLECTION *



35167
Assiette de présentation Ø 30,5 cm



35166
Assiette à pain Ø 13 cm

BROADWAY  COLLECTION *



35169
Assiette de présentation Ø 32 cm



35168
Assiette à pain Ø 16 cm

GOLDRING • BERNARDAUD  COLLECTION *



35902
Assiette de présentation Ø 31,5 cm



35901
Assiette à pain Ø 18 cm

* Produits extraits de l'offre Options Collection. Retrouvez plus de produits sur www.options.net en recherchant « Options collection » ou demandez le catalogue Options Collection.



LIGNES D'ASSIETTES

GAMME EXCELLENCE
★★★★

CAPRI **COLLECTION** *



35852
Assiette de présentation
bleue Ø 32,5 cm



35853
Assiette plate
verte Ø 28 cm



35854
Assiette lunch
rouge Ø 23 cm



35855
Assiette à pain
bleue Ø 17 cm



35856
Assiette à pain
verte Ø 17 cm

OLIVIER **COLLECTION** *

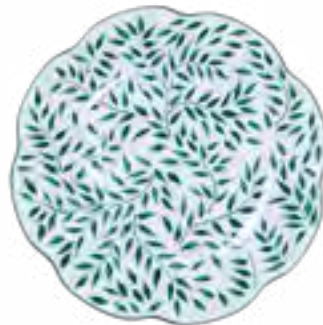

35808
Assiette plate Ø 28 cm

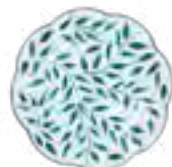

35807
Assiette à pain Ø 16 cm

FANTASIA **COLLECTION** *



35710
Assiette de présentation Ø 33,5 cm
(Assortiment aléatoire)

VAISSELLE VINTAGE

VINTAGE BLANCHE ET DORÉE **vaisselle vintage** **



26049
Petite assiette
Ø 18-20 cm (dépareillée)
26127
Grande assiette
Ø 23-25 cm (dépareillée)

VINTAGE BLEU VERT **vaisselle vintage** **



26071
Petite assiette
Ø 18-20 cm (dépareillée)
26048
Grande assiette
Ø 23-25 cm (dépareillée)

VINTAGE FLEURIE **vaisselle vintage** **



26042
Petite assiette
Ø 18-20 cm (dépareillée)
26043
Grande assiette
Ø 23-25 cm (dépareillée)

** Produits extraits de l'offre Vintage. Retrouvez plus de produits sur www.options.net en recherchant « vintage » ou demandez le catalogue Vaisselle Vintage.

MARQUAGE SUR ASSIETTES



(i) Le marquage éphémère : logo de société, initiales, prénoms des mariés, date d'anniversaire, célébration d'un événement...
Marquage monochrome sur demande.
4 coloris au choix : noir, bleu, rouge et vert.
Le marquage s'efface au premier lavage.
Dimension maximum : 40 x 25 mm.

* Produits extraits de l'offre Options Collection. Retrouvez plus de produits sur www.options.net en recherchant « Options collection » ou demandez le catalogue Options Collection.



LES UNIQUES

DESSOUS D'ASSIETTES ET ASSIETTES DE PRÉSENTATION



DESSOUS D'ASSIETTES ET ASSIETTES DE PRÉSENTATION

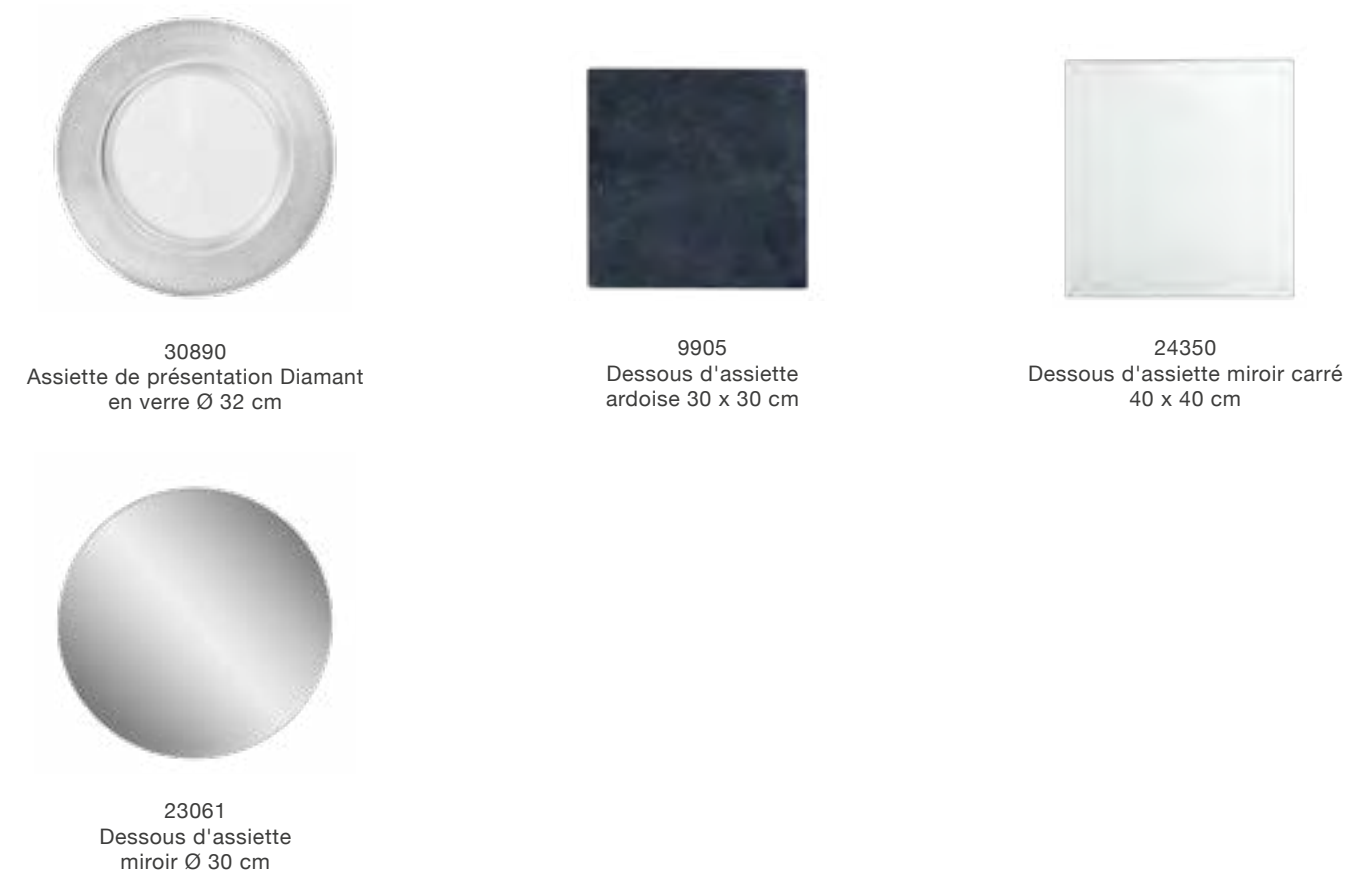
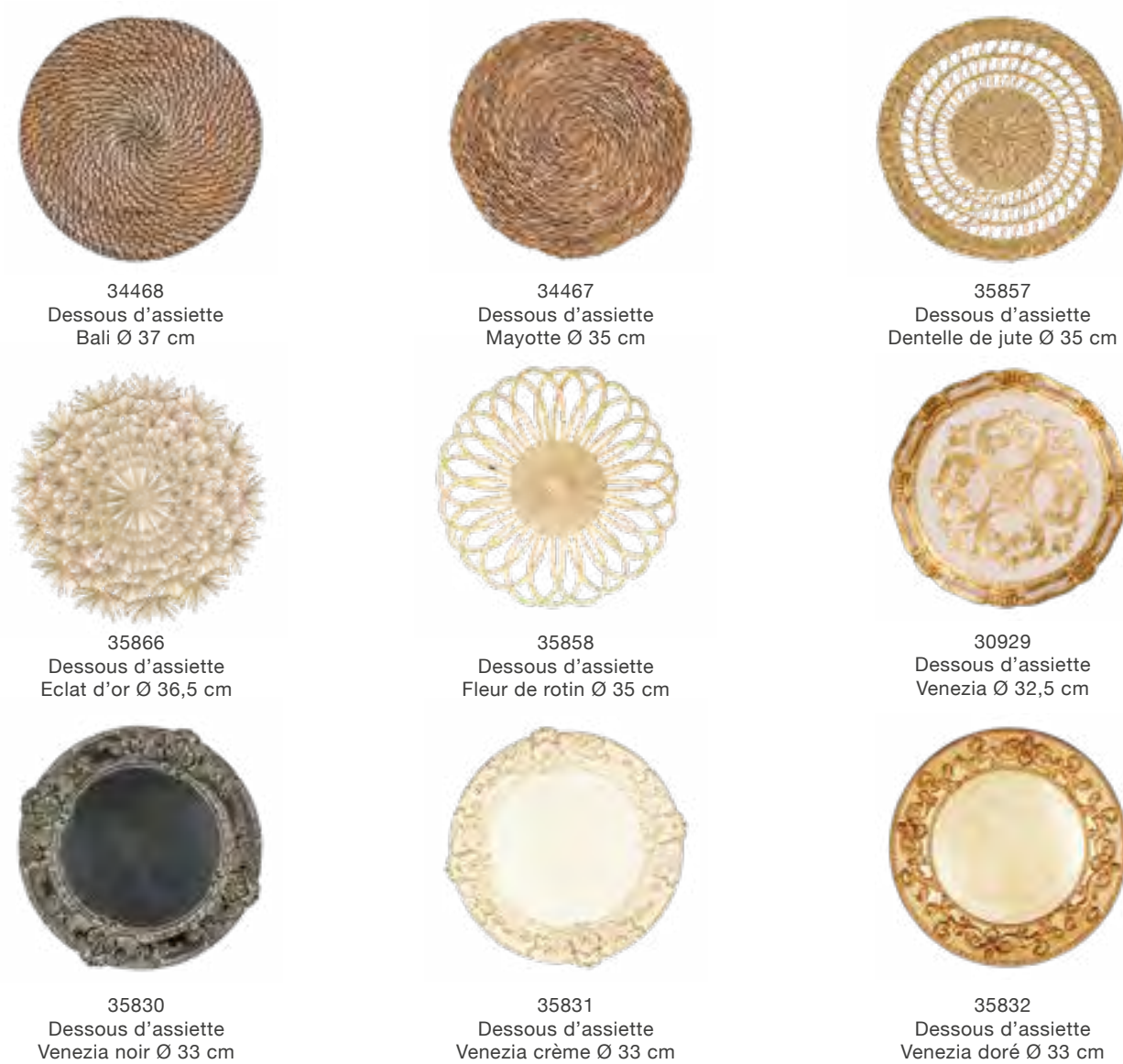

DESSOUS D'ASSIETTES ET ASSIETTES DE PRÉSENTATION

PETITES ASSIETTES COCKTAIL



23076
Assiette de présentation prune
en verre Ø 32 cm



23075
Assiette de présentation noire
en verre Ø 32 cm



23077
Assiette de présentation rouge
en verre Ø 32 cm



23072
Assiette de présentation blanche
en verre Ø 32 cm



23073
Assiette de présentation bleue
en verre Ø 32 cm



21355
Assiette de présentation rose poudré
en verre Ø 32 cm



23078
Assiette de présentation verte
en verre Ø 32 cm



23074
Assiette de présentation taupe
en verre Ø 32 cm



18670
Assiette de présentation
Strass argent Ø 32 cm



19169
Assiette de présentation
Strass fumée Ø 32 cm



20357
Assiette de présentation
Strass noire Ø 32 cm



18671
Assiette de présentation
Strass or Ø 32 cm



18672
Assiette de présentation
Strass prune Ø 32 cm



19170
Assiette de présentation
Strass rouge Ø 32 cm



23069
Assiette à pain prune
en verre Ø 14 cm



23068
Assiette à pain noire
en verre Ø 14 cm



23070
Assiette à pain rouge
en verre Ø 14 cm



23065
Assiette à pain blanche
en verre Ø 14 cm



23066
Assiette à pain bleue
en verre Ø 14 cm



21356
Assiette à pain rose poudré
en verre Ø 14 cm



23067
Assiette à pain taupe
en verre Ø 14 cm



23071
Assiette à pain verte
en verre Ø 14 cm



19898
Assiette à pain
Strass rouge Ø 14 cm



19901
Assiette à pain
Strass argent Ø 14 cm



19897
Assiette à pain
Strass fumée Ø 14 cm



20358
Assiette à pain
Strass noire Ø 14 cm



19900
Assiette à pain
Strass or Ø 14 cm



19899
Assiette à pain
Strass prune Ø 14 cm



4794
Assiette à pain en verre
Ø 12 cm



28339
Assiette à pain en verre filet or
Ø 12 cm



12389
Assiette peintre carbone
18 x 20 cm



22831
Assiette à pain ardoise
10 x 10 cm *



584
Clip à verre



COUVERTS

Lignes de couverts.....	196
Couverts de service.....	218
Autres couverts et petits couverts cocktail.....	219

 : Origine France

 : Origine Union Européenne

LIGNES DE COUVERTS

GAMME STANDARD ★☆☆☆

Biarritz
page 198

Diva
page 198

Vieux Paris inox
page 199

Soho
page 199

Ambre brun
page 210

Cèdre
page 210

Zermatt
page 210

Olga
page 211

GAMME ÉLÉGANCE ★★☆☆

Ronsard
page 204

Genova
page 204

Costa
page 204

Vieux Paris argent
page 205

Art Déco
page 211

Trianon
page 211

Windsor argent
page 214

Olivier
page 214

Louis XIV
page 205

Colbert
page 205

Néo champagne
page 208

Néo cuivré
page 208

Nacre
page 215

Cutipol blanc et or
page 215

GAMME EXCELLENCE ★★★★

Néo doré
page 209

Néo noir
page 209

Windsor
page 216

Soliman
page 216

Pépites or
page 216

Nacre noir et or
page 217

Bague
page 217

RETROUVEZ LES COUVERTS DE SERVICE page 218,
LES AUTRES COUVERTS ET LES PETITS COUVERTS COCKTAIL page 219

LIGNES DE COUVERTS

GAMME STANDARD ★☆☆☆



BIARRITZ (INOX)

- 19106 • Couteau de table
- 19107 • Fourchette de table
- 19108 • Cuillère de table
- 19109 • Couteau à entremets
- 19110 • Fourchette à entremets
- 19111 • Cuillère à entremets
- 20423 • Fourchette à cocktail
- 19112 • Cuillère à café
- 19113 • Cuillère à moka



DIVA (INOX)

- 11443 • Couteau de table
- 11444 • Fourchette de table
- 11445 • Cuillère de table
- 11448 • Couteau à entremets
- 11449 • Fourchette à entremets
- 11450 • Cuillère à entremets
- 11446 • Couteau à poisson
- 11447 • Fourchette à poisson
- 11451 • Cuillère à café
- 11452 • Cuillère à moka

GAMME STANDARD ★☆☆☆



VIEUX PARIS (INOX)

- 207 • Couteau de table
- 208 • Fourchette de table
- 209 • Cuillère de table
- 210 • Couteau à entremets
- 211 • Fourchette à entremets
- 212 • Cuillère à entremets
- 214 • Couteau à poisson
- 215 • Fourchette à poisson
- 213 • Fourchette cocktail coupante
- 298 • Cuillère à café
- 218 • Cuillère à moka
- 217 • Fourchette de service
- 216 • Cuillère de service



SOHO (INOX)

- 25640 • Couteau de table
- 25641 • Fourchette de table
- 25642 • Cuillère de table
- 25643 • Couteau à entremets
- 25644 • Fourchette à entremets
- 25645 • Cuillère à entremets
- 25646 • Cuillère à café
- 25647 • Cuillère à moka





LIGNES DE COUVERTS

GAMME ÉLÉGANCE ★★☆☆



RONSARD

- 4700 • Couteau de table
- 4701 • Fourchette de table
- 4702 • Cuillère de table
- 4703 • Couteau à entremets
- 4704 • Fourchette à entremets
- 4705 • Cuillère à entremets
- 4706 • Cuillère à moka
- 4708 • Fourchette de service
- 4707 • Cuillère de service

GAMME ÉLÉGANCE ★★☆☆



VIEUX PARIS (ARGENT)

- 175 • Couteau de table
- 176 • Fourchette de table
- 177 • Cuillère de table
- 178 • Couteau à entremets
- 179 • Fourchette à entremets
- 180 • Cuillère à entremets
- 184 • Couteau à poisson
- 185 • Fourchette à poisson
- 181 • Fourchette cocktail coupante
- 182 • Cuillère à café
- 183 • Cuillère à moka
- 326 • Cuillère Gourmet
- 187 • Fourchette de service
- 186 • Cuillère de service



GENOVA (INOX) • SANTIAGO BY ALESSI

- 17641 • Couteau de table
- 17642 • Fourchette de table
- 17643 • Cuillère de table
- 17644 • Couteau à entremets
- 17645 • Fourchette à entremets
- 17646 • Cuillère à entremets
- 17647 • Cuillère à moka



COSTA

- 30882 • Fourchette de table
- 30883 • Couteau de table
- 30884 • Cuillère de table
- 30885 • Fourchette à entremets
- 30886 • Couteau à entremets
- 30887 • Cuillère à entremets
- 30888 • Cuillère à moka



LOUIS XIV (ARGENT)

- 732 • Couteau de table
- 733 • Fourchette de table
- 734 • Cuillère de table
- 735 • Couteau à entremets
- 736 • Fourchette à entremets
- 737 • Cuillère à entremets
- 738 • Couteau à poisson
- 739 • Fourchette à poisson
- 740 • Fourchette à cocktail coupante
- 741 • Cuillère à café
- 26940 • Cuillère à moka argent Style



COLBERT (ARGENT)

- 4710 • Couteau de table
- 4711 • Fourchette de table
- 4712 • Cuillère de table
- 4715 • Couteau à entremets
- 4716 • Fourchette à entremets
- 4717 • Cuillère à entremets
- 4713 • Couteau à poisson
- 4714 • Fourchette à poisson
- 4719 • Fourchette cocktail coupante
- 4718 • Cuillère à café
- 26940 • Cuillère à moka argent Style



LIGNES DE COUVERTS

GAMME ÉLÉGANCE ★★☆☆



NÉO CHAMPAGNE

- 35845 • Couteau de table
- 35844 • Fourchette de table
- 35843 • Cuillère de table
- 35842 • Couteau à entremets
- 35841 • Fourchette à entremets
- 35840 • Cuillère à entremets
- 35839 • Cuillère à café
- 35838 • Cuillère à moka

GAMME ÉLÉGANCE ★★☆☆



NÉO DORÉ

- 26931 • Couteau de table
- 26936 • Fourchette de table
- 26933 • Cuillère de table
- 26938 • Couteau à entremets
- 26937 • Fourchette à entremets
- 26934 • Cuillère à entremets
- 26932 • Cuillère à café
- 26935 • Cuillère à moka
- 30483 • Fourchette cocktail



NÉO CUIVRÉ

- 26923 • Couteau de table
- 26929 • Fourchette de table
- 26926 • Cuillère de table
- 26924 • Couteau à entremets
- 26930 • Fourchette à entremets
- 26927 • Cuillère à entremets
- 26925 • Cuillère à café
- 26928 • Cuillère à moka
- 30481 • Fourchette cocktail



NÉO NOIR

- 28352 • Couteau de table
- 28358 • Fourchette de table
- 28356 • Cuillère de table
- 28351 • Couteau à entremets
- 28357 • Fourchette à entremets
- 28354 • Cuillère à entremets
- 28353 • Cuillère à café
- 28355 • Cuillère à moka
- 30482 • Fourchette cocktail

LIGNES DE COUVERTS

GAMME EXCLUSIVE
★★★★☆



AMBRE BRUN

- 35604 • Couteau de table
- 35603 • Fourchette de table
- 35605 • Cuillère de table
- 35607 • Couteau à entremets
- 35606 • Fourchette à entremets
- 35608 • Cuillère à entremets
- 35609 • Cuillère à café
- 35602 • Fourchette de service
- 35601 • Cuillère de service

GAMME EXCLUSIVE
★★★★☆



OLGA (ARGENT) • CHRISTOFLE

- 12819 • Couteau de table
- 12820 • Fourchette de table
- 12821 • Cuillère de table
- 12824 • Couteau à entremets
- 12825 • Fourchette à entremets
- 12826 • Cuillère à entremets
- 12822 • Couteau à poisson
- 12823 • Fourchette à poisson
- 12827 • Cuillère à café
- 12828 • Cuillère à moka



CÈDRE

- 9756 • Couteau de table
- 9757 • Fourchette de table
- 9758 • Cuillère de table
- 9761 • Couteau à entremets
- 9762 • Fourchette à entremets
- 9763 • Cuillère à entremets
- 9759 • Couteau à poisson
- 9760 • Fourchette à poisson
- 10776 • Fourchette cocktail coupante
- 9765 • Cuillère à moka
- 9766 • Fourchette de service
- 9767 • Cuillère de service



ZERMATT (ACIER) • PUIFORCAT

- 16270 • Couteau de table
- 16271 • Fourchette de table
- 16272 • Cuillère de table
- 16267 • Couteau à entremets
- 16268 • Fourchette à entremets
- 16269 • Cuillère à entremets
- 17607 • Couteau à poisson
- 17608 • Fourchette à poisson
- 16285 • Cuillère à moka



ART DÉCO (ARGENT)

- 529 • Couteau de table
- 530 • Fourchette de table
- 531 • Cuillère de table
- 532 • Couteau à entremets
- 533 • Fourchette à entremets
- 534 • Cuillère à entremets
- 537 • Couteau à poisson
- 538 • Fourchette à poisson
- 535 • Cuillère à café
- 26940 • Cuillère à moka argent Style



TRIANON (ARGENT)

- 24185 • Couteau de table
- 24192 • Fourchette de table
- 24189 • Cuillère de table
- 24186 • Couteau à entremets
- 24193 • Fourchette à entremets
- 24190 • Cuillère à entremets
- 24187 • Couteau à poisson
- 24194 • Fourchette à poisson
- 24188 • Cuillère à café
- 24191 • Cuillère à moka



LIGNES DE COUVERTS

GAMME EXCLUSIVE
★★★★☆



WINDSOR ARGENT

- 30844 • Couteau de table
- 30843 • Fourchette de table
- 30845 • Cuillère de table
- 30847 • Couteau à entremets
- 30846 • Fourchette à entremets
- 30848 • Cuillère à entremets
- 30849 • Cuillère à moka

GAMME EXCLUSIVE
★★★★☆



NACRE

- 21349 • Couteau de table
- 21350 • Fourchette de table
- 21346 • Cuillère de table
- 21348 • Couteau à entremets
- 21347 • Fourchette à entremets
- 21351 • Cuillère à entremets
- 21352 • Cuillère à moka



OLIVIER

- 29885 • Couteau de table
- 29886 • Fourchette de table
- 29887 • Cuillère de table
- 29888 • Couteau à entremets
- 29889 • Fourchette à entremets
- 29890 • Cuillère à entremets
- 29892 • Cuillère à moka



CUTIPOL BLANC ET OR

- 29865 • Couteau de table
- 29866 • Fourchette de table
- 29867 • Cuillère de table
- 29868 • Couteau à entremets
- 29869 • Fourchette à entremets
- 29870 • Cuillère à entremets
- 29871 • Cuillère à café
- 29872 • Cuillère à moka

LIGNES DE COUVERTS

GAMME EXCELLENCE
★★★★



WINDSOR (PLAQUÉ OR) COLLECTION *

- 22706 • Couteau de table
- 22703 • Fourchette de table
- 22707 • Couteau à entremets
- 22704 • Fourchette à entremets
- 22709 • Cuillère à entremets
- 22708 • Couteau à poisson
- 22705 • Fourchette à poisson
- 22710 • Cuillère à moka
- 22711 • Fourchette de service
- 22712 • Cuillère de service

GAMME EXCELLENCE
★★★★



NACRE NOIR ET OR COLLECTION *

- 30953 • Couteau de table
- 30952 • Fourchette de table
- 30954 • Cuillère de table
- 30956 • Couteau à entremets
- 30955 • Fourchette à entremets
- 30957 • Cuillère à entremets
- 30958 • Cuillère à café
- 30959 • Cuillère à moka



SOLIMAN (FEUILLE D'OR) COLLECTION *

- 11866 • Couteau de table
- 11867 • Fourchette de table
- 11868 • Couteau à entremets
- 11869 • Fourchette à entremets
- 11870 • Cuillère à entremets
- 11871 • Couteau à poisson
- 11872 • Fourchette à poisson
- 11880 • Cuillère à café
- 11873 • Cuillère à moka



PÉPITES OR COLLECTION *

- 34432 • Couteau de table
- 34431 • Fourchette de table
- 34433 • Cuillère de table
- 34435 • Couteau à entremets
- 34434 • Fourchette à entremets
- 34436 • Cuillère à entremets
- 34437 • Cuillère à café



BAGUETTE* COLLECTION *

- 19246 • Couteau de table
- 19247 • Fourchette de table
- 19248 • Cuillère de table
- 19249 • Couteau à entremets
- 19250 • Fourchette à entremets
- 19251 • Cuillère à entremets
- 19252 • Cuillère à café
- 19253 • Cuillère à moka

* Produits extraits de l'offre Options Collection. Retrouvez plus de produits sur www.options.net en recherchant « Options collection » ou demandez le catalogue Options Collection.

COUVERTS DE SERVICE



217
Fourchette de service inox
216
Cuillère de service inox



187
Fourchette de service argent
186
Cuillère de service argent



29874
Fourchette de service Cutipol blanc et or
29873
Cuillère de service Cutipol blanc et or



28516
Fourchette de service Néo doré
28515
Cuillère de service Néo doré



28518
Fourchette de service Néo cuivré
28517
Cuillère de service Néo cuivré



28514
Fourchette de service Néo inox
28513
Cuillère de service Néo inox



34429
Cuillère de service Pépites Or
34430
Fourchette de service Pépites Or



9766
Fourchette de service Cèdre
9767
Cuillère de service Cèdre



35602
Fourchette de service Ambre brun
35601
Cuillère de service Ambre brun



24196
Fourchette de service Trianon
24195
Cuillère de service Trianon



4708
Fourchette de service Ronsard
4707
Cuillère de service Ronsard

AUTRES COUVERTS ET PETITS COUVERTS COCKTAIL



20816
Couteau à fromage



567
Couteau à viande



34899
Couteau à viande Emperor



19168
Couteau à steak



4376
Fourchette à huîtres Vieux Paris inox



463
Couteau à huîtres



202
Cuillère à glaçons



7009
Pince à glaçons



145
Couverts à salade



16156
Pince à cornichons en bois



706
Curette à homard



707
Pince à homard



146
Pince à crabe



701
Pince à pâtes



728
Pince salade kermesse



20423
Fourchette cocktail Biarritz



213
Fourchette cocktail Vieux Paris inox



181
Fourchette cocktail Vieux Paris argent



740
Fourchette cocktail coupante Louis XIV



4719
Fourchette cocktail coupante Colbert



10776
Fourchette cocktail coupante Cèdre



30482
Fourchette cocktail Néo noir



30483
Fourchette cocktail Néo doré



30481
Fourchette cocktail Néo cuivré



15590
Fourchette cocktail Caravelle
15588
Couteau tartineur Caravelle
15589
Cuillère cocktail Caravelle



14426
Fourchette bambou 9 cm *



14422
Cuillère Bambou 9 cm *



14441
Cuillère à moka Design



20819
Cuillère à caviar en nacre



VERRES

Lignes de verres	222
Gobelets	240
Verres à cocktail	242

 : Origine France

 : Origine Union Européenne

LIGNES DE VERRES

GAMME STANDARD ★☆☆☆☆

Élégance
page 226

Ballon Vintage
page 226

GAMME ÉLÉGANCE ★★☆☆☆

Gala
page 226

Breteuil
page 226

Diamant
page 227

Baroque
page 227

Tourmaline
page 227

Prune
page 230

Rubis
page 230

Ambre
page 230

Opale
page 230

Fumé
page 230

Noir
page 230

GAMME EXCLUSIVE ★★★★☆

Marquis
page 231

Marquis or
page 231

Marquis platine
page 231

Belle époque
page 231

Ballroom
page 231

Œnologue
page 232

Cisé
page 232

Open Up
page 232

Sublym
page 233

Arom Up
page 233

Reveal Up
page 233

Riedel
page 233

Riedel Tasting
page 233

GAMME EXCELLENCE ★★★★★

Sorrente
page 236

Milano
page 236

Venise
page 236

Volga
page 236

VAISSELLE VINTAGE

Vintage style crystal
page 237

GOBELETS

Comète
page 240

Sillage
page 240

Eau Nologue
page 240

Prisme
page 240

Arlequin
page 240

Duralex
page 240

Gobelet
page 240

Vintage style crystal
page 240

Mélo
page 240

Couleur
page 241

RETROUVEZ LES VERRES À COCKTAIL page 242



LIGNES DE VERRES

GAMME STANDARD ★☆☆☆

ÉLÉGANCE



1400
Flûte 17 cl



1040
Verre 24,5 cl



1041
Verre 19 cl



1042
Verre 14,5 cl

BALLON VINTAGE



26047
Verre 19 cl



584
Clip à verre



18061
Lot de 3 plaques en plexi pour pyramide



GAMME ÉLÉGANCE ★★☆☆

GALA



15719
Flûte 14,5 cl



15722
Verre 31 cl



15721
Verre 25 cl

BRETEUIL



29421
Flûte 16 cl



29424
Verre à eau 23 cl



29423
Verre à vin 17 cl

DIAMANT

GAMME ÉLÉGANCE ★★☆☆



34785
Flûte Diamant 17 cl



34787
Verre 35 cl



34786
Verre 25 cl



34784
Gobelet 32 cl

BAROQUE



20356
Verre 23 cl



20355
Gobelet 20 cl

TOURMALINE BLEU GRIS



29297
Verre 23 cl



29300
Gobelet 18 cl

TOURMALINE ROSE



29295
Verre 23 cl



29298
Gobelet 18 cl

TOURMALINE VERT



29296
Verre 23 cl



29299
Gobelet 18 cl



LIGNES DE VERRES

GAMME ÉLÉGANCE ★★☆☆

PRUNE



11152
Flûte 15 cl



10835
Verre 22 cl



11151
Verre 15 cl

RUBIS



13898
Flûte 15 cl



13899
Verre 22 cl



13900
Verre 15 cl

AMBRE



11156
Flûte 15 cl



11154
Verre 22 cl



11155
Verre 15 cl

OPALE



13904
Flûte 15 cl



13905
Verre 22 cl



13906
Verre 15 cl

FUMÉ



13895
Flûte 15 cl



13896
Verre 22 cl



13897
Verre 15 cl

NOIR



13901
Flûte 15 cl



13902
Verre 22 cl



13903
Verre 15 cl

GAMME EXCLUSIVE ★★★★

MARQUIS



23084
Flûte 19 cl



23092
Verre 35 cl



23085
Verre 25 cl

MARQUIS OR



21626
Flûte 19 cl



28349
Verre 35 cl



21625
Verre 25 cl

MARQUIS PLATINE



28346
Flûte 19 cl



28348
Verre 35 cl



28347
Verre 25 cl

BELLE ÉPOQUE



30875
Flûte 14 cl



30874
Verre 23 cl



30873
Verre 21 cl

BALLROOM



26692
Verre 58 cl



26777
Verre 35 cl

LIGNES DE VERRES

GAMME EXCLUSIVE
★★★★☆

CENOLOGUE 



10147
Flûte grand Champagne 26 cl



11135
Verre 55 cl



11134
Verre 45 cl



10146
Verre 35 cl

CISELÉ 



0418
Flûte 16 cl



0415
Verre 25 cl



0416
Verre 15 cl



0417
Verre 12 cl



0421
Verre à whisky bas 20 cl

OPEN UP 



11930
Flûte 17 cl



11865
Verre 55 cl



11638
Verre 40 cl



12772
Verre Round 37 cl



12864
Verre Pro Tasting 32 cl



14459
Verre 27 cl

SUBLYM 



26262
Flûte 21 cl



26265
Verre 45 cl



26264
Verre 35 cl



15629
Flûte 21 cl



14460
Verre 43 cl



14718
Verre 35 cl

GAMME EXCLUSIVE
★★★★☆

AROM UP 

REVEAL UP 



24268
Flûte 21 cl



24270
Verre 40 cl



24269
Verre 30 cl

RIEDEL 



11105
Verre 40 cl

RIEDEL TASTING 



30680
Flûte 23 cl



30682
Verre 45 cl



30681
Verre 35 cl



LIGNES DE VERRES

GAMME EXCELLENCE ★★★★

SORRENTE **COLLECTION** *



35836
Verre rose 37 cl

MILANO **COLLECTION** *



35835
Gobelet rose 27 cl



35834
Gobelet bleu 27 cl



35833
Gobelet vert 27 cl

VINTAGE STYLE CRISTAL **vaisselle vintage**

Produits extraits de l'offre Vintage. Retrouvez plus de produits sur www.options.net en recherchant « vintage » ou demandez le catalogue Vaisselle Vintage.



26058
Flûte à champagne
(dépareillée)



26159
Verre à pied à eau
(dépareillé)

VENISE **COLLECTION** *



35824
Flûte 25 cl



35825
Verre à pied 30 cl



35826
Gobelet 37 cl

VOLGA **COLLECTION** *



22700
Flûte 16 cl



22702
Verre 26 cl



22701
Verre 19 cl



22818
Gobelet 30 cl





GOBELETS



10210
Gobelet Comète
Ø 8 cm H 10 cm 25 cl



11469
Gobelet sillage
Ø 8 cm H 8 cm 28 cl



14461
Gobelet Eau Nologue
Ø 8 cm H 10 cm 37 cl



26614
Gobelet Prisme
Ø 8 cm H 8 cm 24 cl



13908
Gobelet tulipe fumé
Ø 8,5 cm H 11 cm 28 cl
13907
Gobelet pivoine fumé
Ø 8,5 cm H 11 cm 28 cl



13914
Gobelet tulipe ambre
Ø 8,5 cm H 11 cm 28 cl
13913
Gobelet pivoine ambre
Ø 8,5 cm H 11 cm 28 cl



13916
Gobelet tulipe rubis
Ø 8,5 cm H 11 cm 28 cl
13915
Gobelet pivoine rubis
Ø 8,5 cm H 11 cm 28 cl



13912
Gobelet tulipe prune
Ø 8,5 cm H 11 cm 28 cl
13911
Gobelet pivoine prune
Ø 8,5 cm H 11 cm 28 cl



20348
Verre Arlequin
Ø 8,7 cm H 9 cm 29 cl



25650
Verre Duralex
Ø 8 cm H 8,5 cm 22 cl



27782
Grand gobelet
Ø 7 cm H 11 cm 45 cl



27781
Petit gobelet
Ø 8 cm H 9 cm 35 cl



13910
Gobelet tulipe opale
Ø 8,5 cm H 11 cm 28 cl
13909
Gobelet pivoine opale
Ø 8,5 cm H 11 cm 28 cl



13918
Gobelet tulipe noir
Ø 8,5 cm H 11 cm 28 cl
13917
Gobelet pivoine noir
Ø 8,5 cm H 11 cm 28 cl



20988
Gobelet Cœnologue opale
Ø 7 cm H 9 cm 29 cl



20987
Gobelet Cœnologue noir
Ø 7 cm H 9 cm 29 cl

vaisselle vintage

Produits extraits de l'offre Vintage.
Retrouvez plus de produits sur www.options.net en recherchant « vintage » ou demandez le catalogue Vaisselle Vintage.



26040
Gobelet Vintage
(dépareillé)



30837
Gobelet Mélodie noir Ø 8 cm H 9 cm 24 cl
(4 motifs dépareillés)



30840
Gobelet Mélodie rouge Ø 8 cm H 9 cm 24 cl
(4 motifs dépareillés)



30838
Gobelet Mélodie blanc Ø 8 cm H 9 cm 24 cl
(4 motifs dépareillés)



30841
Gobelet Mélodie bleu Ø 8 cm H 9 cm 24 cl
(4 motifs dépareillés)



30839
Gobelet Mélodie vert Ø 8 cm H 9 cm 24 cl
(4 motifs dépareillés)



9903
Gobelet Murano 28 cl



14467
Gobelet argent
Ø 9 cm H 9,5 cm
36 cl



18702
Gobelet cassis
Ø 9 cm H 9,5 cm
36 cl



14468
Gobelet or
Ø 9 cm H 9,5 cm
36 cl



20989
Gobelet Moon
ambre Ø 6,5 cm
H 9 cm 32 cl



20990
Gobelet Moon
rubis Ø 6,5 cm
H 9 cm 32 cl



20992
Gobelet Moon
prune Ø 6,5 cm
H 9 cm 32 cl



20991
Gobelet Moon
fumé Ø 6,5 cm
H 9 cm 32 cl



23090
Gobelet Moon
bleu Ø 6,5 cm
H 9 cm 32 cl



23091
Gobelet Moon
vert Ø 6,5 cm
H 9 cm 32 cl



35863
Gobelet à thé Oslo
30 cl H 9 cm empilable
35862
Gobelet à café Oslo
26 cl H 7,5 cm empilable



27740
Gobelet Céladon
Ø 7,5 cm H 8 cm 15 cl



27739
Gobelet Ardoise
Ø 7,5 cm H 8 cm 15 cl



27743
Gobelet Pêche
Ø 7,5 cm H 8 cm 15 cl



27742
Gobelet Guimauve
Ø 7,5 cm H 8 cm 15 cl



27741
Gobelet Banquise
Ø 7,5 cm H 8 cm 15 cl

VERRES À COCKTAIL



431
Verre I.N.A.O. 21,5 cl



455
Verre à cocktail 35 cl



24404
Verre Pro Tasting
Blind Test 32 cl



14400
Verre Spirit 10 cl



656
Chope à bière
50 cl



718
Verre à bière
33 cl



10074
Verre à café
24 cl



20076
Verre à mojito
48 cl



9890
Verre à Martini
24 cl



27048
Verre à Martini Or
24 cl



27047
Verre à Martini Cuivre
24 cl



13770
Verre Graphic 34 cl



9638
Verre à thé
transparent 10 cl



20049
Verre à whisky
rose fluo 32 cl



20050
Verre à whisky
vert fluo 32 cl



21485
Verre à whisky
bleu fluo 32 cl



254
Verre à alcool
13 cl



2254
Verre à cognac
35 cl



14399
Verre Pur Malt
30 cl



20048
Coupe à champagne
28 cl



259
Verre à champagne /
vin 18 cl



30539
Verre à Moscow Mule
cuivre 45 cl



34705
Flûte Ibiza
en tritan 24 cl



34706
Verre à vin Ibiza
en tritan 47 cl



34704
Gobelet Ibiza
en tritan 39 cl

i Choisissez les verres en tritan pour leur qualité de résistance (verres incassables), leur légèreté et leur transparence ! Idéals pour les cocktails et soirées en extérieur !



258
Verre à whisky
27 cl



11624
Verre à whisky Club
40 cl



26604
Verre à whisky Baby
28,5 cl



30009
Verre à whisky Lounge
34,5 cl



30538
Verre à whisky haut
Lounge 30 cl

vaisselle vintage

Produits extraits de l'offre Vintage. Retrouvez plus de produits sur www.options.net en recherchant « vintage » ou demandez le catalogue Vaisselle Vintage.



26142
Long drink Vintage



26138
Coupe à champagne
Vintage style cristal

32893
Verre à whisky Riedel
Prisme 26,5 cl

636
Verre à vodka
grand modèle
Ø 5,5 cm H 7 cm 10 cl

264
Verre à vodka
petit modèle
Ø 3,5 cm H 7 cm 4 cl

11493
Verre Baby
Ø 3,5 cm H 10,5 cm 6 cl













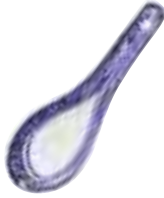











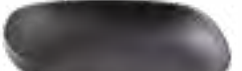































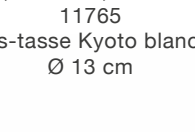

12896
Verre club mini
Ø 3,5 cm H 7 cm 4 cl



**PETITS CONTENANTS,
VERRINES ET BOLS**

* : Articles à la vente

PETITS CONTENANTS, VERRINES ET BOLS

 26939 Cuillère à dégustation noire 4 x 13 cm H 4,5 cm	 9918 Cuillère à dégustation blanche 4 x 12,5 cm	 4490 Cuillère chinoise bleue	 28391 Cuillère à dégustation inox 11,5 cm	 29850 Galet blanc 10 x 6 x 3,5 cm 6 cl	 29851 Galet anthracite 10 x 6 x 3,5 cm 6 cl	 11493 Verre Baby Ø 3,5 cm H 10,5 cm 6 cl	 20741 Cube verre 6 x 6 cm 6 cl	 29835 Tom noir Ø 6,5 cm H 4,5 cm 8 cl
 11773 Cuillère Hélice blanche *	 11774 Cuillère Hélice noire *	 14423 Pétale Bambou 10 x 3,8 cm *	 14425 Carré Bambou 6 x 6 cm *	 29848 Galet blanc 14 x 11 x 3 cm 8 cl	 29849 Galet anthracite 14 x 11 x 3 cm 8 cl	 20069 Tasse à café Carbone 8 cl	 402 Mini bol tête de lion blanc Ø 6 cm H 5,5 cm 8 cl	 20071 Verrine double paroi 6 x 6 cm 8 cl
 14499 Ovale Bambou 7,7 x 6,3 cm *	 14424 Rond Bambou Ø 6 cm *	 11777 Ellipse blanche 11 x 13 cm *	 11776 Ellipse noire 11 x 13 cm *	 23015 Mini cocotte porcelaine blanche Ø 7,2 cm H 3,5 cm 8 cl	 23016 Mini cocotte porcelaine noire Ø 7,2 cm H 3,5 cm 8 cl	 9935 Mini bol rouge fer Ø 7 cm H 4,5 cm 8 cl	 26539 Mini Luz 10 x 8 x 5 cm 9 cl	
 4569 Fuji rond Ø 5 cm H 2,5 cm 2 cl	 9917 Mini pilon blanc Ø 6 cm H 3,5 cm 2 cl	 20073 Mini oursin blanc 5 x 5 cm H 2,5 cm 2 cl	 4568 Fuji carré 7,5 x 7,5 cm H 2,5 cm 2 cl	 11778 Saturne Ø 10 cm H 3 cm 2 cl	 11761 Bol Kyoto blanc Ø 9,5 cm H 3 cm 10 cl	 11762 Bol Kyoto carbone Ø 9,5 cm H 3 cm 10 cl	 636 Verre à vodka grand modèle Ø 5,5 cm H 7 cm 10 cl	 27050 Verrine Variety Ø 6 cm H 6,5 cm 10 cl (dépareillée)
 12907 Nikko rond Ø ext 16 cm Ø int 7 cm	 20877 Bol carbone filet blanc Ø 5 cm H 2,5 cm 2,5 cl	 547 Mini cassolette Ø 7 cm H 2 cm 3 cl	 11797 Mini bol Vésuve Ø 4,5 cm H 3,5 cm 3 cl	 452 Coquetier porcelaine Ø 4,5 cm H 4 cm 4 cl	 456 Ramequin blanc Ø 8 cm H 4 cm 10 cl	 11763 Tasse Kyoto blanche Ø 7,5 cm H 6,5 cm 11 cl	 11764 Tasse Kyoto carbone Ø 7,5 cm H 6,5 cm 11 cl	 29462 Bol Lagon 10 x 8 cm H 3,4 cm 12 cl
 9916 Mini plat carré blanc 6,5 x 6,5 cm H 3 cm 4 cl	 11767 Ovni blanche Ø ext 12,5 cm Ø int 7 cm H 2,5 cm 4 cl	 11768 Ovni carbone Ø ext 12,5 cm Ø int 7 cm H 2,5 cm 4 cl	 12896 Verre club mini Ø 3,5 cm H 7 cm 4 cl	 264 Verre à vodka petit modèle Ø 3,5 cm H 7 cm 4 cl	 11765 Sous-tasse Kyoto blanche Ø 13 cm	 11766 Sous-tasse Kyoto carbone Ø 13 cm		
 20072 Mini cube en verre 4 x 4 cm H 5 cm 4 cl	 801 Bol fleur de lotus Ø 8 cm H 4 cm 5 cl	 11779 Saturne Ø 15 cm H 3,5 cm 5 cl	 12906 Nikko rectangulaire 12 x 3 cm H 3 cm 6 cl	 17648 Petit suisse en porcelaine 6 cl	 20878 Bol carbone filet blanc Ø 8 cm H 4,5 cm 12,5 cl	 35861 Bol Fukuma Ø 9 cm H 4,5 cm 13 cl	 592 Cocotte à manche Ø 9 cm 14 cl	 15591 Verre Baloon Ø 5 cm H 8 cm 15 cl



PETITS CONTENANTS, VERRINES ET BOLS





MATÉRIEL POUR LE SERVICE

Seaux à champagne.....	254
Bols à punch et bonbonnes	255
Brocs et carafes	256
Réhausse.....	257
Plateaux et platerie.....	262
Légumiers, saladiers, saucières et cloches.....	270
Grès et tajines	274
Corbeilles à pain et fruits.....	275
Thé et café.....	276

SEAUX À CHAMPAGNE



20497
Seau à glace inox Equinox
Ø 14 cm H 13 cm



19668
Seau à champagne inox
Equinox Ø 20 cm H 20 cm



149
Seau à champagne argent
Ø 20 cm H 20 cm



12727
Seau à champagne Design
Ø 19 cm H 21 cm



19165
Seau à champagne Pep's
Ø 20 cm H 23 cm



12894
Seau à champagne noir
Ø 20 cm H 25 cm



27041
Vasque à champagne Filo
30 x 46 cm H 23 cm



30876
Seau à glace Filo
Ø 27 cm H 18 cm



20718
Seau à glace Pep's
Ø 10 cm H 9 cm



27116
Vasque à champagne lumineuse
21 x 48 cm H 24,3 cm



20876
Limonadier 9 cm



202
Cuillère à glaçons



7009
Pince à glaçons

BOLS À PUNCH ET BONBONNES



15727
Bol à punch Equinox
Ø 37 cm 1,2 L



30537
Saladier en verre
Ø 27 cm H 18,5 cm 650 cl



263
Louche
à punch



16228
Oeno crachoir
Ø 22 cm H 20 cm 2 L



20880
Bonbonne rétro
Ø 25 cm H 45 cm 12,5 L



24335
Bonbonne rétro
Ø 25 cm H 45 cm 12,5 L
sur réhausse H 10 cm



26128
Bonbonne Vintage à robinet
20 x 17,5 cm H 40 cm 6,6 L



27062
Bonbonne Vintage à robinet
20 x 17,5 cm H 40 cm 6,6 L
sur réhausse H 15,5 cm



425
Fontaine à cocktail
Ø 40 cm H 60 cm 1,5 L 220 V



554
Porte-seau
Ø 19 cm H 70 cm
H 70 cm



2371
Shaker inox 60 cl



20820
Pilon noir à mojito



651
Cuillère à soda

BROCS ET CARAFES



12895
Carafe Aqua
120 cl



265
Carafe à vin
100 cl



20716
Carafe à décanter
Grand Vin 140 cl



4454
Broc Design
150 cl



458
Broc Gala
150 cl



19184
Broc Pep's
150 cl



30588
Carafe Vague
150 cl



10784
Broc Cylindre
120 cl



12891
Broc Cylindre blanc
150 cl



12892
Broc Cylindre noir
150 cl



13920
Verseuse Sensation
inox 175 cl



20526
Verseuse Equinoxe
200 cl

RÉHAUSSES



23082
Plat porcelaine sur pied
Ø 22,5 cm H 7 cm



23083
Plat porcelaine sur pied
Ø 29,5 cm H 9 cm



20493
Plat porcelaine sur pied
Ø 35 cm H 10 cm



153
Coupe basse argent
Ø 26 cm H 8 cm

154
Coupe haute argent
Ø 26 cm H 17 cm



11852
Coupe basse Mermoz
Ø 35 cm H 10 cm



155
Coupe 3 étages argent H 47 cm,
plateaux Ø 35, 30 et 26 cm

156
Coupe 3 étages argent H 68 cm,
plateaux Ø 45, 35 et 28 cm



26037
Serviteur 3 étages Vintage
Fleuri



30893
Plat en verre sur pied
Ø 24 cm H 10 cm

30894
Plat en verre sur pied
Ø 30 cm H 19 cm



27016
Réhausse bois Jaipur
Ø 15 cm H 10,5 cm

27017
Réhausse bois Jaipur
Ø 21 cm H 20 cm



28009
Petit présentoir Banquise
Ø 15 cm H 10,5 cm

28014
Grand présentoir Banquise
Ø 21 cm H 20 cm



28010
Petit présentoir Guimauve
Ø 15 cm H 10,5 cm

28015
Grand présentoir Guimauve
Ø 21 cm H 20 cm



28008
Petit présentoir Céladon
Ø 15 cm H 10,5 cm

28013
Grand présentoir Céladon
Ø 21 cm H 20 cm



28011
Petit présentoir Pêche
Ø 15 cm H 10,5 cm

28016
Grand présentoir Pêche
Ø 21 cm H 20 cm



28007
Petit présentoir Ardoise
Ø 15 cm H 10,5 cm

28012
Grand présentoir Ardoise
Ø 21 cm H 20 cm



188
Pelle à gâteau
argent



13800
Pelle à tarte
Vieux Paris inox



26891
Couteau
de service inox

RÉHAUSSES



20109
Support de plat en bois empilable blanc (à l'unité)

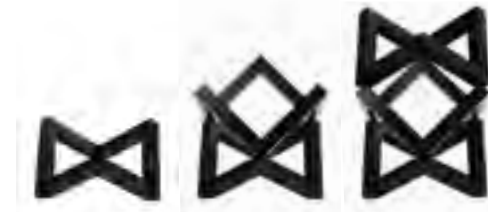

20108
Support de plat en bois empilable noir (à l'unité)



20110
Support de plat en bois empilable rouge (à l'unité)



19402
Support de plat en bois empilable gris (à l'unité)



18200
Réhausse inox
20 x 20 cm H 30 cm (par 2)



18108
Réhausse inox
20 x 18,5 cm H 20 cm (par 2)
18079
Plateau acier perforé 35 x 55 cm



9927
Support de plat en fer
Ø 25 cm H 10 cm
4498
Support de plat en fer
Ø 22 cm H 19 cm



27020
Réhausse Cambridge
dorée Ø 15 cm H 10,5 cm
27021
Réhausse Cambridge
dorée Ø 21 cm H 20 cm



27018
Réhausse Cambridge
acier Ø 15 cm H 10,5 cm
27019
Réhausse Cambridge
acier Ø 21 cm H 20 cm



28394
Réhausse bois nature
20 x 20 cm H 17,5 cm



28393
Réhausse bois noir
20 x 20 cm H 17,5 cm



11793
Support de plat en verre
Ø 15 cm H 20 cm



11864
Support de plat en verre
Ø 25 cm H 30 cm



11780
Support de plat en verre
15 x 15 cm H 20 cm



11789
Support de plat en verre
23 x 23 cm H 30 cm



19423
Lot de 3 réhausse cylindre givrées
Ø 15 cm H 15 cm
Ø 20 cm H 20 cm
Ø 23 cm H 27 cm



19195
Lot de 3 réhausse cylindre Strass anthracite
Ø 15 cm H 15 cm
Ø 20 cm H 20 cm
Ø 23 cm H 27 cm



19196
Lot de 3 réhausse cylindre Strass argent
Ø 15 cm H 15 cm
Ø 20 cm H 20 cm
Ø 23 cm H 27 cm



20892
Lot de 3 réhausse blanches
20980
Lot de 3 réhausse noires
25 x 25 x 25 cm
20 x 20 x 20 cm
15 x 15 x 15 cm



25675
Réhausse Bambou
17 x 17 cm H 20 cm



25676
Réhausse Bambou
15 x 15 cm H 10 cm



19193
Lot de 3 réhausse cylindre Strass rouge
Ø 15 cm H 15 cm
Ø 20 cm H 20 cm
Ø 23 cm H 27 cm



19194
Lot de 3 réhausse cylindre Strass or
Ø 15 cm H 15 cm
Ø 20 cm H 20 cm
Ø 23 cm H 27 cm



25709
Lot de 3 réhausse gigognes blanches
25 x 50 x 20 cm
22 x 45 x 15 cm
22 x 40 x 10 cm



25710
Lot de 3 réhausse gigognes noires
25 x 50 x 20 cm
22 x 45 x 15 cm
22 x 40 x 10 cm



27572
Lot de 3 réhausse gigognes rouges
25 x 50 x 20 cm
22 x 45 x 15 cm
22 x 40 x 10 cm



PLATEAUX ET PLATERIE

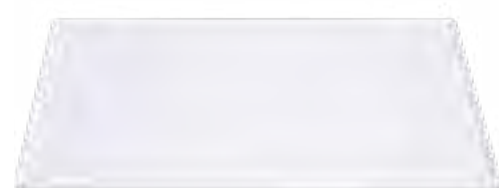

27008
Plateau Soft blanc 40 x 60 cm



27012
Plateau Soft noir 40 x 60 cm



18384
Plateau à anses Sensation 40 x 60 cm



400
Plateau à anses inox 47 x 60 cm



9907
Plateau Cèdre 40 x 60 cm
avec plaque en verre 32 x 53 cm



25678
Plateau Bambou 40 x 60 cm



18079
Plateau acier perforé 35 x 55 cm



11760
Plateau à anses Mermoz 35 x 49 cm



4510
Plateau rectangulaire Louisiane 46 x 63 cm
avec plaque en verre



4511
Plateau carré Louisiane 40 x 40 cm
avec plaque en verre



162
Plateau à anses argent 40 x 51 cm



16179
Plateau argent Louis XVI 30 x 40 cm



27007
Plateau Soft blanc 30 x 40 cm



27011
Plateau Soft noir 30 x 40 cm



161
Plateau argent 30 x 40 cm



199
Plateau inox 30 x 40 cm



17974
Plateau Sensation 23,5 x 41 cm



28392
Plateau Soft doré 30 x 40 cm



25677
Plateau Bambou 30 x 40 cm



10810
Plateau Cèdre 30 x 40 cm
avec plaque en verre 24 x 36 cm



PLATEAUX ET PLATERIE



29895
Plateau à main Soft blanc
24 x 18 cm



29894
Plateau à main Soft noir
24 x 18 cm



27006
Plateau à main Bambou
15 x 25 cm H 2,5 cm



11164
Plateau Carbone porcelaine
30 x 40 cm



9906
Plateau ardoise
30 x 40 cm



25657
Plateau Iko noir mat sur pieds
30 x 40 cm H 2,8 cm



11163
Plateau à main Carbone
15 x 25 cm



16177
Plateau à main argent
Louis XVI 17 x 22 cm



167
Plateau à main argent
15 x 20 cm



206
Plateau à main inox
15 x 20 cm



16148
Plateau Bambou 24 x 36 cm



25656
Plateau Iko noir mat sur pieds
20 x 30 cm H 2,8 cm



16165
Plateau de service noir
antidérapant
Ø 37 cm



201
Plateau de service inox
Ø 40 cm



27009
Plateau de service blanc
antidérapant
Ø 39,5 cm H 3 cm



27010
Plateau de service noir
antidérapant
Ø 39,5 cm H 3 cm



29826
Planche de présentation
20 x 60 cm



29896
Planche de présentation
30 x 100 cm
A utiliser avec la réhausse bois nature page 259



30877
Plateau de service Bambou
Ø 40 cm



20821
Plateau ovale Hôtel antidérapant
L 68 cm l 55 cm



709
Plateau à fruits de mer
Ø 50 cm



309
Support de plateau
H 20 cm

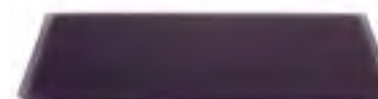

18371
Plateau résine prune 20 x 30 cm
18366
Plateau résine prune 30 x 40 cm



18367
Plateau résine anthracite 20 x 30 cm
18362
Plateau résine anthracite 30 x 40 cm



18370
Plateau résine rose 20 x 30 cm
18365
Plateau résine rose 30 x 40 cm



463
Couteau à huîtres



706
Curette à homard



707
Pince à homard



146
Pince à crabe



18369
Plateau résine fuchsia 20 x 30 cm
18364
Plateau résine fuchsia 30 x 40 cm

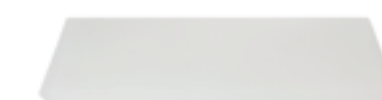

18368
Plateau résine blanc 20 x 30 cm
18363
Plateau résine blanc 30 x 40 cm

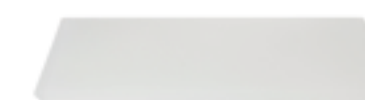

20817
Plateau blanc à fromages
30 x 40 cm



650
Planche à saumon
90 x 22 cm



4580
Plateau de table
tournant Ø 30 cm



20816
Couteau à fromages

PLATEAUX ET PLATERIE



489
Plat Vêrone 30 x 30 cm



488
Plat Vêrone 20 x 45 cm



16290
Plat rectangulaire Karo 27 x 39 cm



166
Plat rond argent
Ø 35 cm



344
Plat rond inox
Ø 35 cm



163
Plat ovale argent
60 cm

446
Plat ovale argent
30 x 70 cm

193
Plat ovale argent
35 x 80 cm



11474
Plat recto 20 x 35 cm



12898
Plat carré fumé noir en verre 29 x 29 cm



11582
Plat écume 35 x 49 cm



16178
Plat rond argent Louis XVI
Ø 35 cm



16181
Plat ovale argent Louis XVI
33 x 52 cm



16180
Plat ovale argent Louis XVI
46 x 59 cm



27005
Plat porcelaine blanc 32 x 48 cm H 2,7 cm



21354
Plat porcelaine ovale 31 x 45 cm



245
Plat sabot porcelaine
26 x 36 cm H 6 cm 300 cl



8989
Plat Extra flat rectangulaire
34 x 23 cm



26860
Plat Extra flat
Ø 31 cm



16230
Plat rectangulaire
21,5 x 32 cm



30879
Plat ovale allongé noir
38,5 x 15 cm



30878
Plat ovale allongé blanc
37 x 15 cm



16234
Plat rectangulaire blanc
en verre 24 x 32 cm



16232
Plat rectangulaire gris nacré
en verre 24 x 32 cm



16233
Plat rectangulaire noir
en verre 24 x 32 cm



331
Plat ovale argent
31 x 45 cm

165
Plat ovale argent
33 x 50 cm

164
Plat ovale argent
40 x 60 cm



203
Plat ovale inox
40 x 60 cm



12905
Nikko rectangulaire coupelle
14,5 x 7 cm



4567
Fuji rectangulaire
12 x 24 cm



26944
Fuji rectangulaire noir
15 x 25 cm



20070
Petit plateau ardoise
12 x 24 cm

LÉGUMIERS, SALADIERS, SAUCIÈRES ET CLOCHES



491
Légumier argent
Ø 18 cm H 7 cm 100 cl



168
Légumier argent
Ø 22 cm H 8 cm 200 cl



223
Légumier inox
Ø 25 cm H 10 cm 300 cl



681
Saladier blanc
Ø 25 cm H 10 cm 200 cl



21353
Saladier porcelaine
Ø 25 cm 220 cl



23020
Saladier résine blanc
Ø 28 cm H 15,5 cm 380 cl



23021
Saladier résine noir
Ø 28 cm H 15,5 cm 380 cl



24140
Légumier sur pied argent
Ø 18 cm



192
Louche de table argent
221
Louche de table inox



16174
Saucière argent
Louis XVI 50 cl



23019
Saladier résine blanc
Ø 46 cm 1080 cl



20761
Saladier résine noir
Ø 46 cm 1080 cl



20763
Saladier résine noir
Ø 60 cm 2520 cl



170
Saucière argent
H 7 cm 25 cl



200
Saucière inox
H 8 cm 20 cl



26822
Saucière
porcelaine blanche
19 x 9 cm H 6 cm



189
Cuillère à sauce
argent



15960
Cocotte ronde avec couvercle
Ø 22 cm H 11 cm 300 cl



226
Soupière blanche tête de lion
Ø 20 cm H 15 cm 280 cl



27736
Saladier Banquise
Ø 26 cm H 10 cm 350 cl



27737
Saladier Guimauve
Ø 26 cm H 10 cm 350 cl



21489
Rafraîchisseur à caviar
250 g Ø 14 cm H 10 cm



316
Cloche assiette inox petit modèle
Ø 23,5 cm H 11 cm
21043
Cloche assiette inox grand
modèle Ø 25,5 cm H 14 cm



24259
Cloche en verre
Ø 24,5 cm H 19 cm



27735
Saladier Céladon
Ø 26 cm H 10 cm 350 cl



27738
Saladier Pêche
Ø 26 cm H 10 cm 350 cl



27734
Saladier Ardoise
Ø 26 cm H 10 cm 350 cl



10785
Saladier Bilbao
Ø 30 cm H 20 cm 500 cl



3707
Saladier Gala grand modèle
Ø 32 cm H 18 cm 600 cl
11520
Saladier Gala moyen modèle
Ø 30 cm H 10 cm 200 cl



30537
Saladier en verre
Ø 27 cm H 18,5 cm 650 cl



728
Pince salade
kermesse



145
Couverts à salade



702
Petite pince pelle



GRÈS ET TAJINES



2521
Pot à condiments
avec couvercle 1000 cl H 26 cm



16156
Pince à cornichons
en bois H 25 cm



0380
Saladier en grès Ø 28 cm H 14 cm



453
Verre à thé
de couleur 10 cl



4755
Bol Sarrazin
Ø 12,5 cm H 7 cm 40 cl



4758
Plat Sarrazin Ø 33 cm H 9 cm



4760
Tajine Sarrazin Ø 30 cm



4753
Saladier Sarrazin Ø 20 cm H 8 cm



4754
Saladier Sarrazin Ø 35 cm H 14 cm



4750
Vase boule Sarrazin
Ø 30 cm H 32 cm



4752
Broc Sarrazin 130 cl
Ø 14 cm H 20 cm

CORBEILLES À PAIN ET FRUITS



29968
Poste à pain Polo

29831
Corbeille à pain Polo
34 x 26 cm H 12,5 cm
29832
Corbeille à pain Polo
34 x 26 cm H 20 cm
29833
Planche à pain Polo
48 x 32 cm H 2 cm
29834
Couteau à pain Polo
lame 20 cm



17984
Couteau à pain
lame de 20 cm



370
Corbeille à fruits style osier
Ø 46 cm H 18,5 cm



131
Corbeille à buffet osier
Ø 31 cm



130
Corbeille de table osier
Ø 22 cm



34722
Corbeille à pain individuelle
Mayotte Ø 11 cm H 5 cm



4504
Plateau à anses ovale
Louisiane 46 x 69 cm



4505
Plateau à anses ovale
Louisiane 36 x 53 cm



4502
Corbeille à fruits
Louisiane Ø 27 cm



4503
Corbeille à fruits
Louisiane Ø 41 cm



29837
Corbeille Vigo ovale
36 x 24 cm H 8,5 cm



29836
Corbeille Vigo ronde
Ø 31 cm H 8 cm



25651
Corbeille à buffet
Equinox Ø 32 cm



20498
Corbeille à pain
Equinox Ø 20 cm H 8,5 cm



18341
Corbeille à pain argent
Biarritz Ø 20 cm H 7,5 cm



30850
Corbeille Filor
Ø 15 cm H 6,5 cm

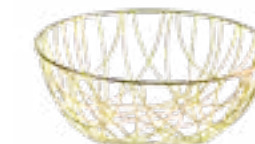

30851
Corbeille Filor
Ø 25 cm H 10 cm

THÉ ET CAFÉ



28140
Théière blanche 170 cl



28364
Cafetière blanche 140 cl



28371
Sucrier blanc 25 cl



28374
Crémier porcelaine 22 cl



13921
Cafetière Sensation
inox 175 cl



13922
Théière Sensation
inox 90 cl



13923
Crémier Sensation
inox 35 cl



13924
Sucrier Sensation
inox



28362
Théière blanche
Filet argent 170 cl



28365
Cafetière blanche
Filet argent 140 cl



28373
Sucrier blanc
Filet argent 25 cl



20527
Cafetière Equinox 150 cl



20528
Théière Equinox 70 cl



24583
Crémier Equinox 30 cl



20529
Coupelle Equinox 18 cl
Ø 9 cm H 5 cm



28361
Théière blanche
Filet or 170 cl



28366
Cafetière blanche
Filet or 140 cl



28372
Sucrier blanc
Filet or 25 cl



204
Verseuse inox 150 cl



172
Théière argent 100 cl
224
Théière inox 100 cl



308
Pot à lait argent 19 cl



173
Sucrier argent



24198
Cafetière Neptune
argent 100 cl



24199
Théière Neptune
argent 100 cl



24200
Pot à lait Neptune
argent 19 cl



24197
Sucrier Neptune
argent



20525
Théière porcelaine
Carbone inox 150 cl



639
Théière porcelaine
blanc inox 140 cl



20075
Pince à sucre inox



24201
Pince à sucre Neptune



190
Bol argent
Ø 11,5 cm H 5,5 cm 40 cl



THÉ ET CAFÉ



244
Pot à lait porcelaine 35 cl



20492
Pot à lait Carbone 15 cl



11855
Crémier blanc Dune 15 cl



24590
Sucrier porcelaine blanche



20697
Machine à café Nespresso NY 220V
+ 50 doses de café
L 40 cm I 20 cm H 30 cm
Temps de chauffe 25 secondes
Réservoir de 2L d'eau



560
Machine Miko avec verseur en verre
220 V - 2,18 kW.
Capacité : 2 x 1,7 L
Production : 20 L par heure
Maintient le café chaud
Livré avec 1 paquet de 4 doses
de Café Equitable.
L 21 cm I 22 cm H 52 cm. 15 Kg



16237
Machine à café Miko
avec verseur isotherme inox
220 V - 2 kW.
Capacité : 1,7 à 2 L
Production : environ 2 L en 5 mn.
L 20,9 cm H 55,2 cm P 37 cm. 6 Kg
Livré avec 1 paquet de 4 doses
de Café Equitable.



30891
Mug blanc
Ø 8 cm H 9 cm



19861
Mug porcelaine
blanche 29 cl



30869
Tasse et sous-tasse
à café blanche 23 cl



30872
Tasse et sous-tasse
à thé blanche 30 cl



20071
Verrine double paroi
6 x 6 cm 8 cl



20172
Verrine double paroi
9 x 8 cm 25 cl



9913
Tasse et sous-tasse à café 7 cl



11407
Tasse et sous-tasse à thé 21 cl



28395
Verre Durablex
Moka 9 cl



35863
Gobelet à thé Oslo
30 cl H 9 cm empilable



35862
Gobelet à café Oslo
26 cl H 7,5 cm empilable



18005
Thermoverseur inox
chauffant 15 L



16183
Samovar argent
18 L H 60 cm



27063
Bouilloire électrique
Equinoxe 10 L
Dimensions :
Ø 20,5 cm H 50,5 cm
Temps de chauffe : 30 min



25310
Machine à café Equinoxe 12 L
Capacité : 12 litres - 96 tasses
Durée de préparation max : 50 min
Alimentation électrique : 230 V
Puissance : 1500 W
Dimensions : 275 x 540 mm
Poids à vide : 4,9 kg



12869
Dose de café Nespresso
décaféiné (par 50) *



12868
Dose de café Nespresso
(par 50) *



16282
Café équitable pour machines
0560 et 16237
Paquet de 4 doses *



614
Bouilloire électrique 170 cl



571
Verseuse isotherme 100 cl



26200
Verseuse Alfi Isacier 150 cl



25708
Appareil à émulsion
Aeroccino 220 V
Pour environ 2 tasses.
Convient pour faire de la
mousse de lait chaude et froide

Retrouvez les tasses et sous-tasses parmi les lignes d'assiettes page 154 à page 187.



MATÉRIEL D'ANIMATION

⊛ : Articles à la vente

MATÉRIEL D'ANIMATION



158

Nécessaire à buffet chaud 2 brûleurs L 62 H 38 P 36 cm
1020

Nécessaire à buffet chaud électrique L 62 H 38 P 36 cm
Corps de chauffe de 700W



21181

Compartment petit modèle (GN 1/2)
6,5 cm de profondeur

159

Compartment petit modèle (GN 1/2)
10 cm de profondeur

21180

Compartment grand modèle (GN 1/1)
6,5 cm de profondeur

160

Compartment grand modèle (GN 1/1)
10 cm de profondeur



616

Couvercle de petit compartiment
2160

Couvercle de grand compartiment



11573

Nécessaire à buffet chaud
électrique Palace

11574

Nécessaire à buffet chaud
1 brûleur Palace



11661

Compartment porcelaine
de nécessaire Palace



20545

Nécessaire à buffet chaud électrique
Hublot avec support
Corps de chauffe de 270W



157

Réchaud à saucisses argent
L 30 | H 15 H 27 cm



394

Réchaud fil argent
L 35 H 12 P 25 cm



426

Réchaud rond argent
H 36 cm Ø 27 cm



20543

Fourchette de service Hublot
20544

Cuillère de service Hublot



277

Alcool gélifié 225 g • *



705

Alcool gélifié 80 g • *



i

Composition : 1 marmite Ø 24 cm,
1 marmite Ø 22 cm, 1 marmite Ø 20 cm,
1 marmite Ø 18 cm, 2 marmites Ø 14 cm,
1 plaque vitro-céramique de maintien
en température et 1 réchaud à induction

20524

Poste à pâtes Equinox



701
Pince
à pâtes



997

Cartouche gaz
pour réchaud de poste
à pâtes • *



20479

Marmite Equinox
Ø 24 cm 510 cl
avec couvercle transparent



20478

Marmite Equinox
Ø 18 cm 210 cl
avec couvercle transparent



25711

Casserole Equinox
Ø 20 cm 290 cl
avec couvercle transparent



22948

Casserole Equinox
Ø 14 cm 100 cl
avec couvercle transparent
(compatible tous feux)



20481

Marmite Equinox
Ø 22 cm 720 cl
avec passoire



20463

Poêle Equinox
Ø 28 cm
avec revêtement



20464

Poêle Equinox
Ø 28 cm

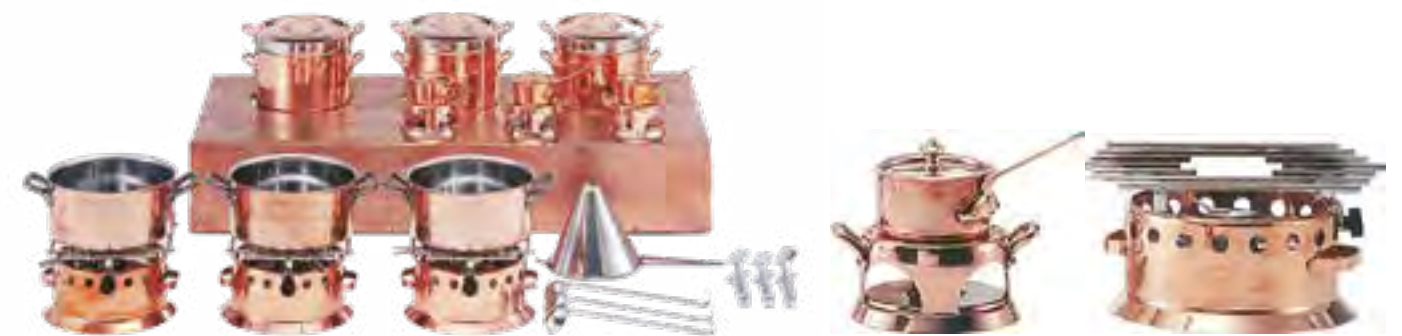

994

Poste à pâtes cuivre électrique

995

Poste à pâtes cuivre gaz

711

Mini poêlon Ø 9 cm
avec réchaud et couvercle

4796

Réchaud à flamber
en cuivre Ø 31 cm

i

Composition : 3 mini poêlons Ø 9 cm avec réchaud et couvercle,
3 réchauds à flamber en cuivre, 3 pinces à pâtes, 1 chinois, 3 pochons

MATÉRIEL D'ANIMATION



20363
Cocotte Taj black and white
Ø 32 cm 300 cl



20372
Cocotte black and white
Ø 26 cm 340 cl



20491
Ensemble black and white
Composition : 1 cocotte Taj black and white Ø 32 cm, 1 cocotte black and white Ø 26 cm, 1 cocotte black and white Ø 19 cm, 1 cocotte black and white Ø 10 cm, 1 plaque vitro-céramique de maintien en température



20369
Cocotte black and white
Ø 19 cm 150 cl



20366
Cocotte black and white
Ø 10 cm 20 cl



27076
Cocotte transparente
Ø 24 cm H 19,5 cm 9,5 L



15634
Plaque hamburger vitro-céramique 220 V - 2,5 kW.
L 40 P 65 H 10 cm. 15 Kg
Surface utile : 32 x 47,8 cm
Plaque de cuisson en vitre céramique.
1 récupérateur de graisses, 1 thermostat, 1 voyant de contrôle. Mise en température très rapide. Consommation réduite.



785
Plaque à snacker plancha 220 V / 16A monophasé 3,3 kW.
Ext. : L 60 l 40 H 19 cm.
Température maxi 300°C.
Livré avec 1 tiroir à sauce. 59 Kg



27061
Grill électrique 230 V - 3,6 kW
40 x 60 cm H 15 cm.
Mise en température : 5 min
T° réglable entre 50 et 320°C
13 Kg



476
Grill à panini 220 V / 16 A monophasé 2,2 kW. Réglage thermostatique.
Ext : L 40 ; l 28,5 ; H 26 / 47 cm (position levée).
Plaque L 24,5 x P 20 cm. 15 Kg



419
Hot-dogger 220 V / 16 A monophasé - 650 W
1 couvercle, 1 manchon Ø 20 cm, 1 grille Ø 17,5 cm, 1 socle chauffant avec bac à eau.
Ext. : L 45 ; l 29 ; H 42 cm. 13 Kg



24485
Centrifugeuse Puissance de 700 W
Débit : 120 litres / h ou 1 verre de jus de fruit en 7 secondes



15141
Blender Mixeur H 38 ; P 21 ; L 17 cm
5,2 Kg - 230 V - 500 W
Bol d'une contenance de 1,25 litres



11565
Wok électrique 1400 W - 220 V - Ø 36 cm.
2 poignées, cuve émaillée.
Livré avec 1 couvercle en verre et 1 grille. H 14 cm. 3 Kg



20434
Réchaud à induction petit modèle pour wok
Puissance : 230 V 3500 W
Dimensions du réchaud : L 34 x P 44 x H 12,5 cm
Sauteuse wok : Ø 36 cm H 11 cm
Contenance : 6 litres



713
Poêle à paëlla Ø 105 cm avec réchaud H 9 cm.
4 poignées de mobilité. Fournie avec réchaud gaz butane dont 3 rampes indépendantes (Ø 21, 40 et 58 cm) et boutons de réglages. 30 Kg
759
Poêle à paëlla Ø 70 cm avec réchaud



32802
Trépied réglable pour réchaud à paëlla



27090
Machine à granité 10 L
Dimensions 28 x 47 cm H 69 cm
25 Kg
Puissance : 460 W
Pour granité, frappé, sorbet liquide, yaourt frappé, cocktails. N'utiliser qu'avec des sirops pour granité.
Thermostat réglable



27112
Tireuse à bière 26 x 27,5 cm H 39 cm
Capacité : 30 L / heure
2 têtes de soutirage
Temps de refroidissement : 5 min
Livrée avec 50 gobelets en complément
27448
Gobelets à bière 35 cl (par 50)



27078
Distributeur de boisson réfrigérant 5 L
22 x 33 cm H 50 cm
Puissance : 60 W 230 V 50Hz
Réservoir : Ø 17 cm H 28 cm
Ne convient pas pour les jus à pulpe épaisse



20598
Conteneur isotherme sans jauge
Contenance 20 L
Pour la conservation et la distribution de boissons chaudes
Équipé d'un robinet anti-goutte et de poignées
Dimensions : H 576 mm. Ø 307 mm.
Hauteur de déversement : 120 mm. 10,3 Kg



MATÉRIEL D'ANIMATION



379
Machine à pop-corn
220 V / 16A monophasé - 1,6 kW.
Chauffe contrôlée par thermostat.
Livrée avec une pelle à pop-corn
Ext. : L 47 ; I 43 ; H 78 cm. 44 Kg
2690
Cornet à pop-corn (à l'unité) *



16274
Fontaine à chocolat
petit modèle 230 V monophasé.
H 80 cm Ø 39 cm - 8 Kg.
Capacité : 2 à 5 Kg de chocolat
environ. Température régulée
par thermostat de 0° à 39°C.
Moteur très silencieux



11701
Fontaine à chocolat
220 V - 400 W / 16A
H 100 cm
Ø du socle 45,5 cm
26,5 Kg.
Capacité : 8 à 10 Kg
de chocolat environ



12930
Pistoles de chocolat
lait caramel
31,4 % cacao 5 Kg *

12929
Pistoles de chocolat
noir 64 % cacao 5 Kg *



28211
Trancheuse manuelle rétro rouge
sur pied H 155 cm



27091
Machine à pop-corn sur chariot
56 x 42 cm H 156 cm
Livrée avec une pelle à pop-corn
566
Pelle à pop-corn



28579
Plancha gaz 4 feux sur chariot
50 x 91 cm



375
Machine à barbe à papa
220 V / 16A - 2 kW. Ext. : L 60 ; P 66 ;
H 41 cm et 70 cm avec la protection.
Bassine Ø 58 cm.
Mise en route 15 secondes.
Livrée avec 200 bâtonnets.
Colorant sur demande.
43 Kg (photo non contractuelle)



2375
Bâton de barbe à papa (par 100) *

25057
Sucre bleu pour
barbe à papa parfum framboise 1 Kg *

25056
Sucre rose pour barbe à papa parfum
chewing gum 1 Kg *



25202
Réchaud à induction
230 V - 3 kW
Dessus en verre
vitrocéramique de 4 mm
Double inducteur Ø 180 et 280 mm
Affichage digital du niveau
de puissance et de la minuterie
Ext. : L 39,2 ; P 52,6 ; H 9 cm.
8,5 Kg



128
Barbecue en fer
Ext. : L 152 ; P 60 ; H 95,5 cm
103
Charbon de bois 50 L



19264
Barbecue gaz
20 kW. Fourni avec une bouteille de gaz
propane 13 Kg et avec 2 bacs de récupération
Surface de travail : L 171 ; I 66 ; H 79 cm
Surface de cuisson : L 160 ; I 45,7 cm. 47 Kg



11563
Barbecue à méchoui gaz
avec tournebroche électrique
Livré avec une bouteille
de gaz propane
230 V - 50 Hz
144,3 Kg avec la bouteille



18107
Plaque vitro-céramique
de maintien en température horizontale
24639
Plaque vitro-céramique
de maintien en température verticale
600 W - surface utile : 40 x 60 cm.
Touche de contrôle tactile - Sélection
de la température avec indication
par Led - Température maxi : 90 °C
Ext. : L 46 ; P 70 ; H 35 cm. 15 Kg



20773
Lot de 2 caches socle
pour matériel d'animation
(réglable en longueur)
40 x 40 x 17 cm



19378
Appareil à raclette
220 V - 16A - 900 W
Ext : L 26,5 ; I 53 ; H 25 cm
mini et 40 cm maxi.
Réglage de la hauteur du boîtier
de chauffe par crémaillère.
Cuisson très rapide de 30 à 45 sec.
environ. Est composé d'un socle,
d'un axe, d'une résistance et d'un
cordon d'alimentation. 3,70 Kg



572
Fourchette à viande 32 cm
369
Couteau de cuisine
lame de 20 cm



573
Pince à steak



576
Pince à barbecue
40 cm



103
Charbon de bois
50 L *



992
Allume barbecue *



23063
Lampe chauffe plat
sur pied pour buffet
275 W
H 79 cm - 6 Kg



28591
Vitrine réfrigérée
30 x 64,5 cm H 33,5 cm
105 W / 230 V - de 0 à 12°
Ext. : 67 x 57,5 cm H 33,5 cm
Surface exposition : 64,5 x 30 cm
H 26 cm 40 L



642
Pince à jambon
Socle : L 25 ; I 45 cm.
Pince intérieure :
L 30 ; I 10 à 15 cm. 7 Kg



11754
Couteau à jambon
lame de 30 cm



086
Liteau blanc



20823
Liteau noir

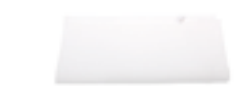

087
Torchon



19222
Veste maître d'hôtel noire
boutons couleur acier taille S
18817
Veste maître d'hôtel noire
boutons couleur acier taille M
18818
Veste maître d'hôtel noire
boutons couleur acier taille L
18819
Veste maître d'hôtel noire
boutons couleur acier taille XL
18820
Veste maître d'hôtel noire
boutons couleur acier taille XXL



ACCESSOIRES DE TABLES ET BUFFETS

Potelets de table294

Ronds de serviette295

Salières, poivrières et moutardier298

Beurriers, dessous de bouteille et cendriers299

* : Articles à la vente

POTELETS DE TABLE



12775
Potelet de table acier
H 31 cm



144
Potelet de table doré
H 26,5 cm



19500
Potelet de table chromé
H 31 cm



4400
Porte-menu argent
H 12 cm

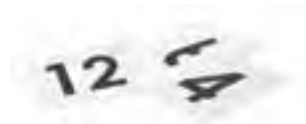

20531
Numéro de table carré souple 1 à 30 • (*)
20535
Numéro de table carré souple 1 à 50 • (*)
20536
Numéro de table carré souple 1 à 100 • (*)
20537
Numéro de table carré souple 1 à 150 • (*)



28282
Porte-menu plexi A4



14330
Grande ardoise de table
sur socle en bois
20 x 30 cm • (*)



13560
Ardoise
30 x 19,8 cm



22228
Mini ardoise de restaurant
20 x 45 cm



20066
Marque-place Prestige or
10 x 4,5 cm plié
(lot de 10) • (*)



20067
Marque-place Prestige argent
10 x 4,5 cm plié
(lot de 10) • (*)



13784
Rond de serviette Virgule



19160
Rond de serviette Biarritz



4692
Rond de serviette Design



4434
Rond de serviette passementerie



34465
Rond de serviette Godron

RONDS DE SERVIETTE



4461
Rond de serviette feuille laiton
(dépareillé)



35427
Rond de serviette
Ovale doré



35426
Rond de serviette
Ginkgo



13783
Rond de serviette Prisme



19336
Rond de serviette Etoile



34466
Rond de serviette
Octogonal en verre



13939
Rond de serviette Havane



13940
Rond de serviette ivoire



19154
Rond de serviette résine
Cléopâtre or



19155
Rond de serviette résine
Cléopâtre argent



24121
Rond de serviette noir



24122
Rond de serviette rouge



4499
Rond de serviette Louisiane



11575
Rond de serviette Cèdre



29523
Rond de serviette César



29699
Rond de serviette Perles



34464
Rond de serviette Triangle



SALIÈRES, POIVRIÈRES ET MOUTARDIER

BEURRIERS, DESSOUS DE BOUTEILLE ET CENDRIERS



257
Salière en verre
(sel non fourni)
10036
Poivrière en verre
(poivre non fourni)



11791
Salière ogive
(sel non fourni)
11792
Poivrière ogive
(poivre non fourni)



19157
Salière Prisme
(sel non fourni)
19156
Poivrière Prisme
(poivre non fourni)



27022
Salière en porcelaine blanche
Ø 3,2 cm H 6,2 cm
(sel non fourni)
27014
Poivrière en porcelaine blanche
Ø 3,2 cm H 6,2 cm
(poivre non fourni)



2001
Salière Ronsard
(sel non fourni)
2002
Poivrière Ronsard
(poivre non fourni)



9768
Salière Cèdre
(sel non fourni)
9769
Poivrière Cèdre
(poivre non fourni)



19159
Salière Biarritz
(sel non fourni)
19158
Poivrière Biarritz
(poivre non fourni)



11889
Moulin à sel en plexi H 11 cm
(sel non fourni)
11890
Moulin à poivre en plexi H 11 cm
(poivre non fourni)



35869
Salière filet or Ø 3,2 cm H 3,5 cm
(sel non fourni)
35868
Poivrière filet or Ø 3,2 cm H 3,5 cm
(poivre non fourni)



354
Moulin à poivre
Ø 5 cm H 14 cm
(poivre non fourni)



4611
Moulin à poivre
Ø 8 cm H 28 cm
(poivre non fourni)



21236
Moutardier blanc
Ø 5 cm H 6,5 cm
et sa cuillère



10092
Beurrier en verre
avec sa cloche
Ø ext 10 cm Ø int 5,5 cm
H 6 cm



11384
Beurrier en porcelaine
avec cloche en inox
Ø 9 cm H 8 cm



197
Dessous de bouteille argent
Ø 11,5 cm



26275
Dessous de bouteille inox
Ø 11,5 cm



18647
Cendrier en verre carré
8 x 8 cm



18648
Cendrier en verre rond
Ø 9 cm



260
Cendrier en verre prisme rond
Ø 11 cm



20818
Cendrier porcelaine rond
avec couvercle
Ø 10 cm H 6 cm



307
Cendrier blanc porcelaine
7 x 10 cm



10022
Cendrier noir ardoise carré
9 x 9 cm



ACCESSOIRES DE DÉCORATION

Chandeliers, bougies et accessoires lumineux302

Vases, centres de table et rubans de satin308

Plantes artificielles.....309

Accessoires vintage310

* : Articles à la vente

CHANDELIERS, BOUGIES ET ACCESSOIRES LUMINEUX



151
Chandelier 3 feux
argent H 25 cm



289
Chandelier 5 feux
argent bas H 25 cm



376
Chandelier 5 feux argent
haut octogonal H 51 cm



34499
Lot de 3 bougeoirs
transparents sur pied
H 46 cm - 38 cm - 30 cm



34459
Lot de 3 bougeoirs
dorés sur pied
H 40 cm - 35,5 cm - 30,5 cm



35431
Lot de 3 bougeoirs boule
Colonel en verre
H 27 cm - 23 cm - 20 cm



4520
Bougeoir 1 feu argent
Hamilton H 18 cm



24242
Chandelier 5 feux
H 52 cm



11757
Chandelier à
pampilles 5 branches



13094
Chandelier noir
à pampilles 5 branches



30898
Lot de 3 bougeoirs en verre
H 19 cm - 24 cm - 30 cm



23058
Bougie porte-bougie
Ø 8 cm H 18 cm
(avec bougie)



23057
Bougie porte-bougie
Ø 8 cm H 15 cm
(avec bougie)



23056
Bougie porte-bougie
Ø 8 cm H 12 cm
(avec bougie)



454
Photophore
Ø 4,5 cm H 7,5 cm
(autonomie 9 h) *



21450
Photophores Country
H 7 cm (lot de 3)
(dépareillés) *



22837
Photophore
à suspendre Ø 6,5 cm H 6
cm H totale 14 cm *



23115
Chandelier 5 feux
H 75 cm



23116
Chandelier 5 feux gris
H 75 cm



7395
Chandelier en fer forgé
Ø 83 cm H 75 cm



29306
Lampe autonome Prisme
H 22 cm



36062
Lampe de table Dôme
H 21,2 cm Ø 8,8 cm
Alimentation autonome



25715
Lampe Cosy
H 25 cm
Alimentation autonome



24808
Sphère lumineuse
Ø 50 cm
Alimentation autonome

Couleurs programmables
avec une télécommande



CHANDELIERS, BOUGIES ET ACCESSOIRES LUMINEUX

 34788 Photophore Som Ø 5 cm H 5,7 cm	 13778 Photophore Prisme Ø int 5 cm Ø ext 6,5 cm H 5,5 cm	 20347 Photophore Luberon Ø 8 cm H 9 cm	 19164 Photophore Venise tressé Ø 9 cm H 9,5 cm	 18706 Photophore Pépité Ø 8 cm H 7 cm	 30436 Lot de 12 flambeaux rouges H 30 cm * (✳)	 30435 Lot de 12 flambeaux noirs H 30 cm * (✳)	 30433 Lot de 12 flambeaux blancs H 30 cm * (✳)	 30434 Lot de 12 flambeaux ivoires H 30 cm * (✳)	 30432 Lot de 12 bougies Classiques Or 30 cm * (✳)	
 11586 Photophore Capri blanc Ø int 5 cm Ø ext 6,5 cm H 6 cm	 35476 Photophore Murano rouge H 8 cm Ø 10 cm	 35475 Photophore Murano ambre H 8 cm Ø 10 cm	 35483 Photophore Murano camel H 8 cm Ø 10 cm	 25546 Photophore Opale Ø 5,4 cm H 8 cm	 30429 Lot de 6 bougies brossées or H 25 cm * (✳)	 30430 Lot de 6 bougies brossées rouge opéra H 25 cm * (✳)	 30428 Lot de 6 bougies brossées lin H 25 cm * (✳)	 35944 Lot de 6 bougies effilées cassis H 32 cm * (✳)	 35945 Lot de 6 bougies effilées taupe H 32 cm * (✳)	 35946 Lot de 6 bougies effilées beige H 32 cm * (✳)
 35813 Lot de 3 photophores Filo H 12 / 10 / 8 cm	 4404 Photophore baroque bleu foncé Ø 5 cm H 6,5 cm	 4403 Photophore baroque ambre Ø 5 cm H 6,5 cm	 29658 Photophore Aman Ø 8,5 cm H 9,5 cm	 30412 Lot de 4 bougies ivoires cylindre Ø 6 cm H 20 cm * (✳) 20644 Bougie cylindre ivoire H 15 cm (unité) * (✳) 20645 Bougie cylindre ivoire H 10 cm (unité) * (✳)	 30410 Lot de 4 bougies blanches cylindre Ø 6 cm H 20 cm * (✳) 23052 Bougie cylindre blanche H 15 cm (unité) * (✳) 23051 Bougie cylindre blanche H 10 cm (unité) * (✳)	 20720 Flambeau électrique noir à pile H 29 cm (autonomie 8h)	 15726 Flambeau électrique à pile H 29 cm (autonomie 8h)	 11636 Bougie à LED ambre Ø 3,8 cm * (✳)		
 11794 Photophore corail Ø 5,5 cm H 6,5 cm	 11795 Photophore vert pistache Ø 5,5 cm H 6,5 cm	 24355 Photophore pour bougie chauffe-plat Ø 5 cm H 2,5 cm * (✳)	 20974 Support de bougies en zinc motif point Ø 8 cm * (✳)	 29846 Photophore Day Gold Ø 7,5 cm H 6 cm 29847 Photophore Night Gold Ø 7,5 cm H 6 cm	 20613 Bougie LED blanche Ø 3,8 cm (autonomie 8 à 10h) Pile fournie * (✳)	 22914 Boule lumineuse Ø 8 cm * (✳)	 15595 Boule lumineuse multicolore Ø 8 cm * (✳)	 15596 Cube lumineux multicolore 7 x 7 x 7 cm * (✳)	 22737 Glaçon lumineux transparent 3,5 x 3,5 x 3,5 cm * (✳)	
 30391 Lot de 4 bougies boule argent Ø 10 cm * (✳) 30393 Lot de 4 bougies boule argent Ø 8 cm * (✳)	 30398 Lot de 4 bougies boule or Ø 10 cm * (✳) 30397 Lot de 4 bougies boule or brossée Ø 8 cm * (✳)	 30404 Lot de 4 bougies boule satinée ivoire Ø 10 cm * (✳) 30405 Lot de 4 bougies boule satinée ivoire Ø 8 cm * (✳)	 30408 Lot de 4 bougies boule satinée vieux rose Ø 10 cm * (✳)	 30394 Lot de 4 bougies boule blanche Ø 10 cm * (✳)	 15170 Lanterne de jardin blanche 15 x 15 cm H 26 cm (lot de 5) * (✳)	 35928 Photophore avec bougie LED Ø 4,5 cm H 10 cm * (✳)	 35898 Guirlande 12 LEDs gouttes d'eau blanc froid 120 cm avec piles	 35899 Guirlande 12 LEDs gouttes d'eau blanc chaud 120 cm avec piles * (✳)		
 30389 Lot de 4 bougies boule argent brossée Ø 10 cm * (✳) 30390 Lot de 4 bougies boule argent brossée Ø 8 cm * (✳)	 30396 Lot de 4 bougies boule or brossée Ø 10 cm * (✳) 30397 Lot de 4 bougies boule or brossée Ø 8 cm * (✳)	 4464 Bougie de verrine/ chauffe-plat Ø 4 cm (autonomie 3 heures) * (✳)	 4433 Bougie votive Ø 4 cm (autonomie 5 heures) * (✳)	 19262 Bougie chauffe plat GM Ø 6 cm * (✳)						

VASES, CENTRES DE TABLE ET RUBANS DE SATIN

PLANTES ARTIFICIELLES



21440
Vases Armoiries
H 12 cm (lot de 3) • *



21439
Vase cylindrique en verre
Ø 10 cm H 40 cm • *



21438
Vase cylindrique en verre
Ø 9 cm H 25 cm • *



24995
Bonbonnière
Ø 6 cm H 11 cm • *



19813
Coupe ronde
Ø 25 cm H 6,5 cm • *



17698
Seau en zinc
Ø 6,5 cm H 5 cm • *



27160
Mousse végétale
(sachet de 500 grs) • *



22980
Perles de pluie transparent
(vendues par seau
de 2,5 L) • *



26526
Boule décorative
blanche en papier
Ø 20 cm • *



27054
Bambou artificiel
H 180 cm avec pot



27082
Haie de bambou artificielle
100 x 40 cm H 150 cm avec pot



27055
Bananier artificiel
H 180 cm avec pot



27096
Palmier artificiel
H 250 cm avec pot



26847
Areca artificiel
H 180 cm avec pot



27095
Olivier artificiel
H 185 cm avec pot



i Rubans de satin à la demande, plusieurs coloris et dimensions possibles.
Délai 72h.



27064
Boule de buis artificielle
Ø 60 cm avec pot



22039
Sapin artificiel
H 185 cm



13652
Branche de sapin
artificielle



28251
Paravent bois flotté
3 panneaux 120 cm H 170 cm

ACCESSOIRES VINTAGE

vaisselle vintage

Produits extraits de l'offre Vintage. Retrouvez plus de produits sur www.options.net en recherchant « vintage » ou demandez le catalogue Vaisselle Vintage.



22239
Malle
61 x 31 cm H 44 cm



13668
Valise
45 x 36 cm H 22 cm



13565
Caisse en bois
55 x 24 H 35 cm



13480
Casier à bouteilles en bois
26 x 66,5 H 34 cm



22281
Panière en bois
28 x 10 cm H 19 cm



13603
Dame jeanne en osier
grand modèle Ø 53 cm H 50 cm



13569
Panier en osier
Ø 26/44 cm H 24/30 cm



13654
Livre v
(à l'unité)



13671
Tapis 280 x 197 cm



13253
Barrière en bois
250 x 100 cm L 8 cm



22050
Pomme de pin
(à l'unité)



22159
Tapis blanc en fourrure
150 x 240 cm



26669
Rondelle de bois
Ø 20 cm



13416
Bûche L 48 cm



25251
Botte de paille
70 x 40 cm H 34 cm



13395
Seau en zinc
Ø 30 cm H 27 cm



22128
Table basse ronde dorée
Ø 89 cm H 49 cm



13725
Pouf marocain
Ø 45/57 cm



ⓘ Drapeaux à la demande, pays au choix. Délai 72h.

vaisselle vintage

Produits extraits de l'offre Vintage. Retrouvez plus de produits sur www.options.net en recherchant « vintage » ou demandez le catalogue Vaisselle Vintage.



22024
Ski H 171/207 cm
et bâtons de ski
98/133 cm en bois



13423
Luge en bois
79,5/130 x 34/40 cm
H 21/24 cm



21807
Escabeau en bois
103/107 x 42,5/45 cm H 170/174 cm



13387
Lampe tempête
Ø 14 cm H 27,5 cm



13391
Tonnelet
Ø 25,5/50 cm



21963
Caisse en bois
76 x 76 x 76 cm



21723
Clap cinéma
23 x 29,8 cm



21843
Bobine de film
Ø 27 cm H 4 cm



ÉQUIPEMENT DE CUISINE

Gros matériel314

Petit matériel320

* : Articles à la vente

GROS MATÉRIEL

TABLES D'OFFICE



558
Table d'office inox
80 x 200 cm sur pieds réglables H 72 ou 92 cm



6785
Table pliante en inox
80 x 200 cm H 90 cm



411
Etuve ventilée humidifiée 8 grilles
220 V / 16A monophasé - 2,2 kW.
Température maxi : 150 °C en 50 min.
Livrée avec 8 grilles gn 2/1 (65 x 53 cm).
Espace entre les grilles : 10,5 cm.
Bloc de ventilation surmonté
d'un bac gn 2/1 et d'un Z antivague.
Ext. : L 77 ; l 93 ; H 162 cm. 135 Kg



293
Four à micro-ondes
220 V / 16A monophasé - 2,5 kW.
Puissance restituée : 1 kW, 20 l.
Plateau tournant Ø 32 cm.
Ext. : L 52 ; P 40 ; H 30 cm.
Int. : L 33 ; P 34 ; H 22 cm. 20 Kg



474
Four professionnel
électrique petit modèle
220 V - 2,5 kW.
Régulation thermostatique
de 0° à 250°. Minuterie.
Livré avec une grille et une
plaque.
Ext. : L 60 ; l 45 ; H 35 cm.
Int. : L 33 ; l 35 ; H 27 cm. 30 Kg

ÉTUVES ET RÉCHAUDS



388
Réchaud électrique 1 plaque
220 V / 16A monophasé - 2,6 kW.
Bouton de réglage
thermostatique.
1 plaque Ø 23 cm.
Ext. : L 35 ; l 45 ; H 17 cm. 11 Kg



389
Réchaud vitrocéramique
220 V / 16A monophasé
- 2,1 kW. Feu Ø 30 cm.
1 bouton de réglage
Ext. : L 42 ; l 42 ; H 10 cm.
8 Kg. de 50 à 270°C.



25202
Réchaud à induction
230 V - 3 kW
Dessus en verre
vitrocéramique de 4 mm
Double inducteur
Ø 180 et 280 mm
Affichage digital du niveau
de puissance et de la minuterie
Ext. : L 39,2 ; P 52,6 ; H 9 cm.
8,5 Kg



118
Réchaud gaz
Livré avec 1 bouteille de gaz
butane (détendeur de 28 mbar).
1 feu trépied. Vis de réglage
de débit de gaz.
L 37 ; l 37 ; H 13 cm. 5 Kg



10823
Four ventilé 6 niveaux
gastro 220 V
Électrique 220 V / 16A
monophasé - 3,5 kW.
Régulation thermostatique
0 à 300°C. Ventilation intégrée.
Livré avec 6 grilles gn.
Ext. : L 58 ; l 93 ; H 94 cm.
103 Kg



397
Four ventilé humidifié
380 V / 32A triphasé
+ neutre 16 kW - Prise P 17.
Réservoir d'eau
autonome, capacité 3 L.
Réglage du thermostat
de 50 à 270°C.
Fourni avec 10 grilles
gn 1/1 (53 x 32,5 cm).
Espace entre les grilles : 6 cm.
Ext. : L 96 ; l 108 ; H 165 cm.
Int. : L 69 ; l 41 ; H 53 cm. 180 Kg



19379
Four ventilé 5 niveaux
220 / 230 V / 16A monophasé.
3 Kw. Livré avec 5 grilles
pâtisseries 600 x 400 gn 1/1.
Piètement avec 5 niveaux.
Ext. : L 86 ; l 76 ; H 159 cm.
151 Kg



27081
Four mixte à vapeur électrique
12,6 kw.
Four 10 niveaux
Raccordement à l'eau
ou autonome (5 L)
11,5 Kg - Espace entre les grilles
7,4 cm
Int.: l 85 x P 65 cm H 96 cm
Ext.: l 95 x P 87 cm H 162 cm



11527
Etuve électrique petit modèle
220/230 V - 16 A monophasé - 2 kW
Température maxi 150°C en 30 min -
Combiné adaptable pâtisserie ou
gastronorme 1/1. Fourni avec 5 grilles
pâtisseries 60 x 40 cm. Espace entre
les grilles : 7 cm. Ext. : L 89 ; P 50,5 ;
H 73 cm. Int. : L 60 ; P 40 ; H 45,5 cm



9938
Etuve électrique ventilée 8 grilles
Electrique 220 V / 16A monophasé
3 kW. 1 prise.
Température maxi : 250°C en 60 min.
Livrée avec 8 grilles pâtisseries 60 x 40 cm.
Espace entre les grilles : 7 cm.
Ext. : L 65 ; l 105 ; H 132 cm.
Int. : L 40,5 x l 60 x H 85,5 cm
150 Kg



10024
Etuve électrique ventilée 16 grilles
Electrique 220 V / 16A
monophasé - 3,6 kW. 1 prise.
Température maxi : 200°C
en 90 min.
Livrée avec 16 grilles pâtisseries.
Ext. : L 79 ; l 125 ; H 130 cm.
Int. : L 60 ; l 80 ; H 85 cm. 217 Kg



668
Friteuse simple
220 V / 16A - 3,5 kW.
Ext. : L 30 ; l 44 ; H 29 cm.
Capacité 7 L 10 Kg
0667
Friteuse double
220 V / 16A - 7 kW. 2 prises
de 3,5 Kw. Ext. : L 51 ; l 44 ; H 29 cm.
Capacité : 2 x 7 L 16 Kg



715
Friteuse double gaz
Livrée avec 1 bouteille de gaz butane
de 20 Kg ; 1 détendeur 28 mbar.
Capacité : 2 x 7L 2 paniers
(L 18 ; l 26 ; H 14 cm).
Ext. : L 52 ; l 60 ; H 59 cm. 21 Kg



2010
Friteuse gaz
Capacité 15 l.
Livrée avec 1 bouteille
de gaz de 20 Kg ;
1 détendeur de 28 mbar
Ext. : L 40 ; l 72 ; H 93 cm.
54 Kg.
18635
Friteuse électrique
380 V / 32A. Capacité 16 L.
Ext. L 40 ; l 70 ; H 99 cm. 35 Kg



20903
Cornet à frites kraft
H 10,5 cm (150 g de frites)
(par 50) * (⊗)

GROS MATÉRIEL

ÉTUVES ET RÉCHAUDS



16340
Rotissoire à balancelle
Dotée de 5 broches,
peut contenir de 15 à 20 poulets.
400 V - 4,9 kW
Ext. : 89 x 85 x 168 cm. 195 Kg



730
Toaster
Commande par commutateur
de chauffe, minuterie et voyant
de contrôle.
Livré avec 2 grilles.
220 V / 16A monophasé -
2,4 kW.



791
Salamandre
220 V / 4,5 kW répartis
en 2 prises de 2,25 kW.

MATÉRIEL DE MAINTIEN EN TEMPÉRATURE



30535
Conteneur isotherme
pour liquide
L x P x H hors tout :
316 x 604 x 437 mm
Poids à vide : 10 kg
Capacité de chargement : 17 L



20538
Conteneur isotherme
avec 8 grilles
L 77,6 cm x l 54,8 cm x H 64,1 cm
Équipé de 8 grilles pâtisseries
60 x 40 cm
Les conteneurs isothermes
sont empilables. 22 Kg



20495
Chariot pour conteneur
isotherme
Équipé de 4 roues
dont 2 avec freins.
Poignée ergonomique



198
Conteneur traiteur
Livré avec 8 grilles
pâtisseries 60 x 40 cm.
Espace entre
les grilles : 6,5 cm.
Possibilité de mettre
un tiroir chauffant.
Ext. : L 66 ; l 43 ; H 71 cm.
Int. : L 60 ; l 41 ; H 64 cm.
21 Kg



328
Réfrigérateur 140 litres
220 V / 16A monophasé - 150 W.
Livré avec 3 grilles
Ext. : L 65 ; l 60 ; H 89 cm. 36 Kg



327
Réfrigérateur 250 litres
220 V / 16A monophasé - 170 W.
Livré avec 4 grilles
Ext. : L 65 ; l 60 ; H 124 cm. 43 Kg



684
Réfrigérateur 500 litres
220 V / 16A monophasé 150 W.
Livré avec 5 grilles 68 x 52 cm.
Ext. : L 80 ; l 80 ; H 180 cm. 95 Kg



17634
Armoire réfrigérée ventilée 400 L
230 V - + 2 à + 15 °C
Livrée avec 5 grilles (49,8 x 42,5 mm)
Ext. : L 70 ; l 65 ; H 175 cm
Int. : L 45,5 ; l 47 ; H 145 cm
82 Kg



720
Plaque gastronomique 1/1
12671
Plaque gastronomique 2/1



716
Grille gastronomique 2/1
712
Grille gastronomique 1/1
286
Grille gastronomique 2/3



19224
Lampe de maintien
en température
230 V - 800 W
Dimensions sous lampe :
L 92 ; l 35 à 40 ; H 28 cm
Pieds pliants - 5 Kg



395
Bain-marie électrique
220 V / 16A monophasé - 2,5 kW.
Temps de chauffe à sec : 30 min.
Commande indépendante
des compartiments.
Thermostat réglable de 30°C à 95°C.
Livré avec 3 bacs gn 1/1.
Ext. : L 122 ; l 70 ; H 90 cm. 55 Kg



20598
Conteneur isotherme sans jauge
Contenance 20 L
Pour la conservation et la distribution
de boissons chaudes
Équipé d'un robinet anti-goutte
et de poignées
Dimensions : H 58 cm Ø 31 cm
Hauteur de déversement : 12 cm
10,3 Kg



27077
Congélateur vertical 170 L
230 V - 2 kW
Int. : L 60 x P 59 cm H 85 cm
Ext. : L 65 x P 66 cm H 111 cm
Température - 18 °C digitale
Grilles réglables



404
Congélateur 600 L
220 V / 16A monophasé - 290 W.
Pouvoir de congélation : 30 Kg / 24 h.
Ext. L 165 ; P 81 ; H 89 cm. 75 Kg



27089
Machine à glaçons
Int. : L 67 x P 56 cm H 98 cm
Ext. : L 72 x P 66 cm H 116 cm
Porte glissant vers l'intérieur - 775W
30 mn de mise en marche et refroidissement
Cycle de 15 mn = 55 glaçons
Production de 75 Kg /24h
Stockage 37 Kg - Poids 60 Kg
En complément : pelle à glaçons page 319

GROS MATÉRIEL

MATÉRIEL À TRANCHER



13341
Trancheur à jambon professionnel
220 V - 370 W / 16 A.
Ext : L 62 ; P 72 ; H 53 cm.
Lame de coupe Ø 35 cm. 36 Kg



11754
Couteau à jambon
lame de 30 cm



36135
Evier lave-mains autonome
Livré avec 1 bidon de réserve d'eau (20 L),
1 bidon pour récupérer l'eau usée (20 L),
1 bidon de savon (15 cl).
Ext. : L 42 ; l 36 ; H 100 cm. 20 Kg



27543
Socle sac poubelle
Possibilité de retirer le couvercle
13767
Sac poubelle 160 L • *



11405
Support sac poubelle à pédale
Monté sur 2 roulettes et 2 pieds.
Ext. : L 58 ; l 48 ; H 107 cm
13767
Sac poubelle 160 L • *

MOBILIER OFFICE, ÉTAGÈRES ET PORTE-ASSIETTES



14039
Étagère PVC
Étagère de cuisine en PVC 4 niveaux.
Ext. : L 200 ; l 57 ; H 174 cm



557
Echelle pâtissière
Livrée avec 15 grilles pâtissières
60 x 40 cm.
Espace entre les grilles : 8 cm.
Ext. : L 67 ; l 45 ; H 171 cm. 37 Kg



16012
Plateau de manutention paraisons
60 x 40 cm pour échelle pâtissière
Le plateau est adapté au format
des échelles pâtissières.
Peut contenir 15 paraisons cocktail

MATÉRIEL DE MANUTENTION ET COMMUNICATION



382
Talkie-walkie
+ le chargeur



797
Diable de manutention
Monté sur 2 roues
pneumatiques
Ø 26 cm. Lame de 20 cm.
Capacité 7 bacs H 20
euronorme.
Ext. : L 50 ; H 145 cm. 18 Kg



1102
Transpalette
L 155 ; l 53 cm. Hauteur du bras
de traction : 123 cm. Support bras
de levage : 2 roues caoutchouc.
Support de fourches : 4 roues nylon.
Capacité de levage : 2 t.
65 Kg

BACS À GLACE



124
Bac à glace à 60 L
Capacité 60 L.
Ext. : L 60 ; l 40 ; H 32 cm.
Int. L 55,5 ; l 35,5 ;
H 30 cm. 2,75 Kg



310
Bac à glace magnum
Capacité 75 L.
Ext. : L 60 ; l 40 ;
H 41 cm.
3,715 Kg



578
Pelle à glaçons



4795
Glace paillette de 20 Kg
+ bac isotherme • *



640
Glace à rafraîchir de 20 Kg
+ bac isotherme • *



15932
Carbo glace sac
de 10,5 Kg • *



10825
Echelle pâtissière isotherme
Echelle pâtissière housée
livrée avec 15 grilles
pâtissières
60 x 40 cm.
Espace entre les grilles 8 cm
Ext. : L 67 ; l 45 ; H 171 cm



17627
Echelle pâtissière Z
Livrée avec 20 grilles pâtissières
60 x 40 cm.
Espace entre les grilles :
7,5 cm. Ext : L 53 ; l 70 ;
H 179 cm. 39,5 Kg



29238
Echelle GN 1/1
46 x 63 cm H 179 cm
Livrée seule.
Espaces entre
les niveaux : 7,5 cm
22 Kg

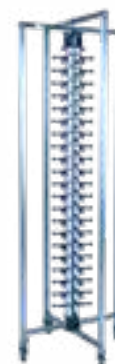

407
Porte-assiettes à tétons
Capacité : 84 assiettes
Ø 34 cm maxi.
H max : 5 cm.
Niveau réglable selon
le modèle des assiettes.
Ext. : L 48 ; P 48 ; H 188 cm
18 Kg

PETIT MATÉRIEL

USTENSILES DE CUISINE



10824
Robot plongeur
220 V / 16A monophasé - 180 W.
Cordon d'alimentation 280 cm ;
tube de plongée
16 cm ; lame Ø 4 cm. 1,2 Kg



17983
Siphon à chantilly



18230
Lot de 3 cartouches
de gaz pour siphon • (*)



545
Fouet grand modèle



606
Fouet petit modèle



544
Planche à découper blanche
32,5 x 53 cm



20822
Plateau à découper anthracite
42 x 50 cm



27002
Planche à découper noire
33 x 45 cm



17986
Poêle cuivre



603
Casserole inox
Ø 29 cm H 15 cm 5,4 L



604
Poêle Téfal



993
Chinois



12944
Entonnoir automatique
en inox avec support



710
Marmite cuivre 5 L



318
Marmite inox
Ø 45 cm H 45 cm 75 L
602
Marmite inox
Ø 40 cm H 40 cm 50 L
428
Marmite inox
Ø 32 cm H 32 cm 25 L



429
Couvercle marmite 25 L
19753
Couvercle marmite 50 L

CONSOMMABLES CUISINE ET COMBUSTIBLES



12869
Dose de café Nespresso
décaféiné (par 50) • (*)



12868
Dose de café Nespresso
(par 50) • (*)



16282
Café équitable pour machines
0560 et 16237
Paquet de 4 doses • (*)



20901
Gobelet carton carbone
12 cl (par 50) • (*)
20902
Gobelet carton carbone
23 cl (par 40) • (*)



30930
Lot de 100 gobelets
kraft 18 cl • (*)
30931
Lot de 50 gobelets
kraft 23 cl • (*)



12930
Pistoles de chocolat lait
caramel 31,4 % cacao 5 Kg • (*)



12929
Pistoles de chocolat
noir 64 % cacao 5 Kg • (*)



11786
Pics Bambou
(par 250) • (*)



110
Pics en bois
(par 100) • (*)



27040
Touillettes bambou
(par 50) • (*)



2375
Bâton de barbe à papa
(par 100) • (*)



2690
Cornet à pop-corn
(à l'unité) • (*)



20903
Lot de 50 contenants
en kraft H 10,5 cm • (*)



25057
Sucre bleu pour
barbe à papa parfum
framboise 1 Kg • (*)



25056
Sucre rose pour
barbe à papa parfum
chewing gum 1 Kg • (*)

PETIT MATÉRIEL

CONSOMMABLES CUISINE ET COMBUSTIBLES



103
Charbon de bois 50 L • *



992
Allume barbecue • *



9584
Kerdane 1 L • *



997
Cartouche gaz
pour réchaud de poste
à pâtes • *



26877
Bûche 30 cm en filet
(pour brasero) • *
i À utiliser avec le brasero
page 105



26878
Bûche d'ambiance
Ø 13 cm H 24 cm
(autonomie 3 à 4 h) • *
i À utiliser avec les photophores
d'extérieur fer forgé page 104



26876
Bougie recharge
pour torche Nomade
(autonomie 9h) • *



277
Alcool gélifié 225 g • *



705
Alcool gélifié 80 g • *



18230
Lot de 3 cartouches de gaz
pour siphon • *



13767
Sac poubelle 160 L • *



4795
Glace paillette de 20 Kg
+ bac isotherme • *



640
Glace à rafraîchir de 20 Kg
+ bac isotherme • *



15932
Carbo glace sac
de 10,5 Kg • *

Photographie

Tanguy de Montesson / Agence Oblique
Félicien Delorme
Alexis Boullay
Thierry Parant

Dessins

Olivier Hubert

Lieu

Les Bergeries - www.domainedesbergeries.com
Pages 2, 16, 17, 48, 56, 60, 64, 78, 87, 88, 102,
168, 184, 202, 206, 207, 220, 234, 244, 248, 278

Fleurs

Reflets de fleurs
Pages 2, 16, 17, 48, 56, 60, 64, 78, 87, 88, 102,
168, 184, 202, 206, 207, 220, 234, 244, 248, 278

Photos non contractuelles

